



## Research Paper

# Techno-Economic Evaluation of Helium Recovery from Natural Gas; A Comparison Between Inorganic and Polymeric Membrane Technology

Shamim Haider <sup>1</sup>, Muhammad Saeed <sup>2</sup>, Arne Lindbråthen <sup>1</sup>, May-Britt Hägg <sup>1,\*</sup>

<sup>1</sup> Norwegian University of Science and Technology, NTNU, Department of Chemical Engineering, 7491 Trondheim, Norway

<sup>2</sup> Electron Microscopy Laboratory at Department of Oral Biology, University of Oslo, UiO, Oslo, 0316 Norway

## Article info

Received 2018-06-11

Revised 2018-07-24

Accepted 2018-07-24

Available online 2018-07-24

## Keywords

He recovery

Membrane process

Techno-economical evaluation

Inorganic membranes

## Highlights

- Inorganic and polymeric membranes to separate He from natural gas
- Two-stage membrane process to achieve 97% pure He with 90% recovery
- Techno-economic analysis to produce He with membrane separation process

## Abstract

Natural gas produced at high pressure (50–70 bar) is the only industrial source of helium (He). A membrane separation process may offer a more efficient production system with smaller footprint and lower operational cost than the conventional cryogenic system. Inorganic membranes with high mechanical strength are known to exhibit good stability at high pressure. In this work, two inorganic membranes, porous silica and carbon molecular sieve (CMS) were studied by simulation for their applicability in the He recovery process and compared against a Matrimid polymeric membrane. An in-house developed membrane simulation model (Chembrane) interfaced with Aspen HYSYS was used to simulate the membrane area and energy requirement for the He separation process. He was separated directly from a mixture containing methane (CH<sub>4</sub>) and 1–5 mole% He in the feed stream, and natural gas containing 1–5 mole% of He in a mixture of CH<sub>4</sub> and N<sub>2</sub>. These streams were considered at 70 bar pressure and 25 °C. Single and two-stage membrane separation processes with and without recycle stream were simulated to achieve 97 mole % purity and 90% recovery of He. The simulation results showed that all three membranes can achieve required purity and recovery in a two-stage separation process. However, a recycle is required while using Matrimid membrane which adds cost and complexity to the system. The highest net present value (NPV) for silica, CMS, and Matrimid membrane was US\$M 2.5, 2, and 1.75, respectively, when 5% He is present in feed gas and 15 years of plant life is considered.

© 2019 MPRL. All rights reserved.

## 1. Introduction

Helium (He) is a colorless, odorless, nonflammable noble gas with low molecular weight (molar mass: 4 g/mol) and boiling point (-269 °C). In recent years, He has gained much importance due to its wide range of industrial and medical applications. Besides its use in high altitude weather balloons, it is used in cryogenic processes, gas chromatography, electron microscopy, welding, heat transfer, food & dairy industry, diagnostics, surgical procedures

and other biological applications [1–4].

A large quantity of He is present in the atmosphere, however, its low concentration in air (~5 ppm) makes it difficult to produce, efficiently. Natural gas is a mixture consisting of mostly methane (CH<sub>4</sub>) and low molecular weight hydrocarbons with impurities like nitrogen (N<sub>2</sub>), carbon dioxide (CO<sub>2</sub>), Helium (He), oxygen (O<sub>2</sub>) and other gases in traces. Among all

## Graphical abstract

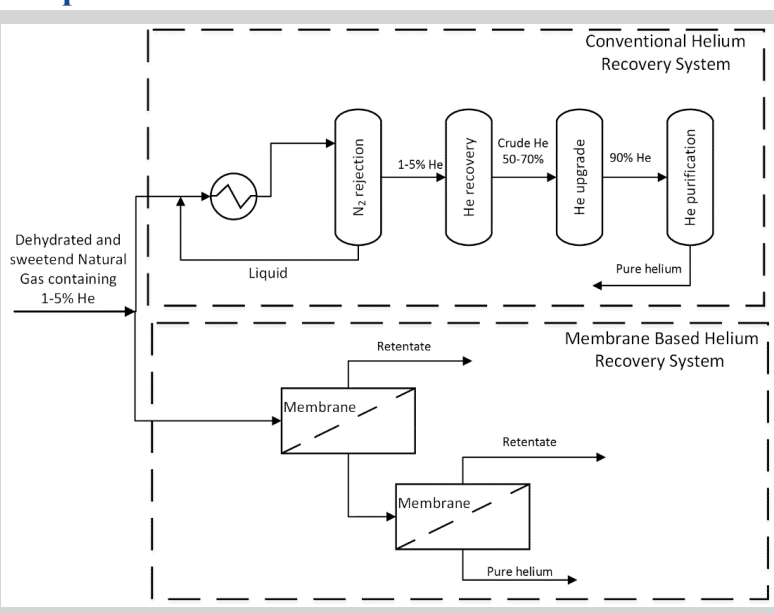

\* Corresponding author at: Phone: +47 93080834; fax: +47 73594080

E-mail address: may-britt.hagg@ntnu.no (M.-B. Hägg)

DOI: 10.22079/JMSR.2018.87998.1196

these impurities, only He is a valuable byproduct. A He-rich natural gas contains He in a range of almost 0.3-5 mole% [5, 6].

Conventionally, He is recovered from natural gas by using energy-intensive cryogenic separation process where liquefied natural gas is distilled to produce crude He (65-80% He) and this is further purified in different stages to yield high purity He. The He recovery system is a multi-stage process involving high pressure and low temperature. In recent years, research has been conducted in the field of pressure swing adsorption and membrane technology to efficiently recover He at a much lower cost. Semipermeable membranes with high He perm-selectivity offer several advantages like small footprint, modular design, simplicity in operation and maintenance, and low capital and operational cost [7, 8]. A schematic diagram of conventional and membrane-based He recovery from natural gas is presented in Figure 1.

Membrane technology has extensively been investigated for He recovery from natural gas. Agrawal and Sourirajan [10] first reported cellulose acetate membrane for He separation from CH<sub>4</sub> and N<sub>2</sub>, in 1969. The reported He/N<sub>2</sub> selectivity varied from 1.99-2.83 and He/CH<sub>4</sub> selectivity from 1.30-1.78. Gantzel and Merten [11] reported asymmetric cellulose acetate membrane with He/N<sub>2</sub> selectivity of 97 and He/CH<sub>4</sub> selectivity of 98 (self supported membrane with wall thickness: 100µm). Chiou and Paul [12] presented Nafion membrane with He/CH<sub>4</sub> selectivity 401. Furthermore, highly He/CH<sub>4</sub> selective membranes based on different (hybrid) materials were reported in literature with a He/CH<sub>4</sub> selectivity over 3000 [13-16]. Similarly, some polymer membranes with high He/N<sub>2</sub> selectivity are also reported in the literature [2, 13, 15, 17]. Although showing high He selectivity over CH<sub>4</sub> and N<sub>2</sub>, however, these membranes do not exceed Robeson upper bound due to low He permeability, and up to now there is no polymer or hybrid membrane which has been successfully commercialized for He recovery from natural gas [18].

Inorganic membranes have been investigated by a few researchers for He recovery. Unlike polymeric membranes, inorganic membranes can be operated at high temperature, pressure, and corrosive environment. Inorganic membranes like carbon molecular sieves (CMS), porous silica, porous aluminum and MOFs show high He permeance along with significant He/N<sub>2</sub> and He/CH<sub>4</sub> selectivities [19-22].

Unlike conventional unit as presented in Figure 1, a single or two-stage membrane-based He recovery unit can be designed to produce pure He with high recovery. A membrane for this purpose needs to be highly permeable and should have significant He/CH<sub>4</sub> and He/N<sub>2</sub> selectivities [23].

Membrane technology for He recovery has been considered since the 1960s. However, most of the work is done in the field of material

development and very little in the field of simulations and modeling. Scholes and Ghosh [24] simulated single stage and multistage polymeric membrane systems for He recovery using Hysys and suggested He/CH<sub>4</sub> and He/N<sub>2</sub> selectivities and operational parameters for efficient He recovery. Ahsan and Hussain [25] developed a mathematical model for membrane gas separation and studied He/CH<sub>4</sub> separation. They considered feed with high He concentration (60% He, 40% CH<sub>4</sub>) and studied the effect of flow rate and stage cut on He recovery. Laguntsov et al. [26] considered the effect of membrane selectivity on He recovery in a two-stage process.

The objective of this work is to present a techno-economical evaluation of high-performance membranes for He recovery from natural gas. Simulation work reported in literature considers polymeric membranes for He separation at high pressure (10MPa). Dense polymeric membranes usually lack high mechanical strength and suffer from compaction and rupturing at such high transmembrane pressure. The novelty of this work is to consider porous inorganic membranes with high He permeability, He/CH<sub>4</sub> and He/N<sub>2</sub> selectivities in a multi-stage membrane system to produce a He-rich stream with 97 mole % purity and 90% recovery. For this work, high-performance CMS and porous silica membranes are selected from the literature. A Matrimid polymeric membrane was also investigated to compare with inorganic membranes. Dehydrated and sweet natural gas at 70 bar containing 1-5% He in CH<sub>4</sub> and N<sub>2</sub> at 25°C was considered as feed stream to the membrane simulation model for He recovery. A techno-economic evaluation was conducted based on optimal membrane area and energy consumption at various concentrations of He in the feed gas.

## 2. Process design, simulation and economic evaluation

### 2.1. Background on membrane model and process simulations

Chembrane, an in-house membrane model based on mass transfer equations for co-current, counter-current, and a perfectly-mixed flow configuration, was interfaced with Aspen Hysys® V9. The thermodynamic fluid package that uses Peng-Robinson equation of state was used to perform all the simulations for He separation with CM. For a shell fed module, based on MemfoACT AS module design [27], the counter-current configuration explains the real behavior of gas flow as the best. Therefore, counter-current configuration was used in the current study. However, other configurations and details of the model can be found elsewhere [28]. A representation of membrane module counter-current configuration is presented in Figure 2.

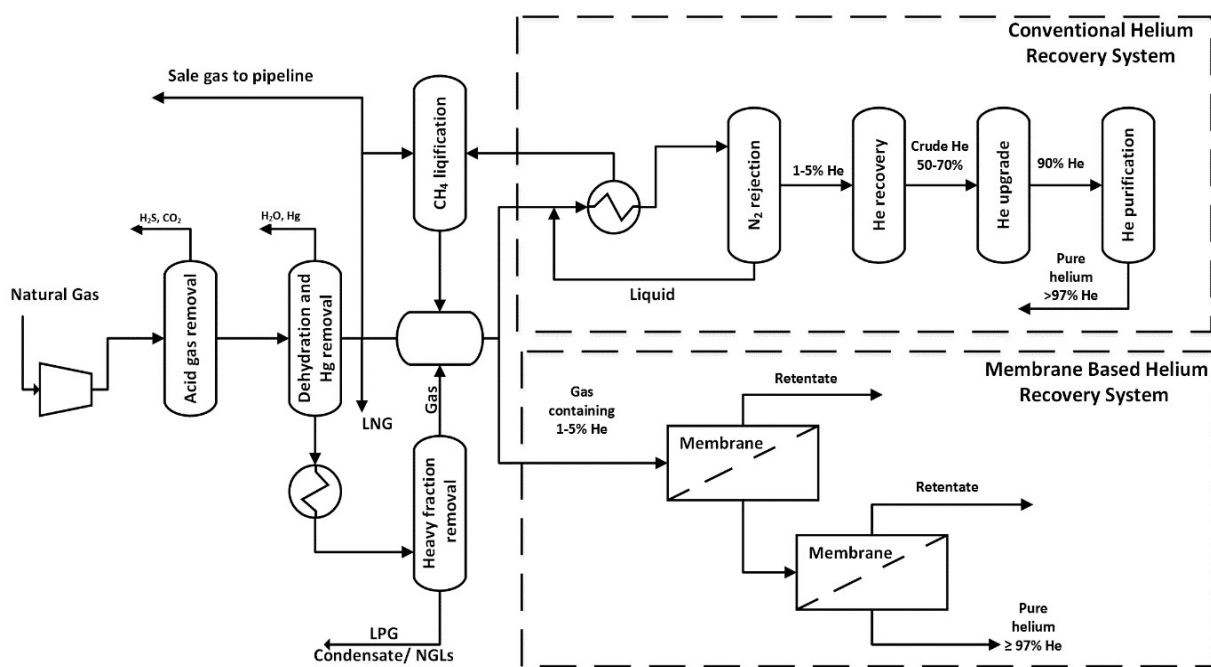

Fig. 1. Schematic diagram of He recovery systems (conventional and membrane-based) from natural gas. Adapted from [9].

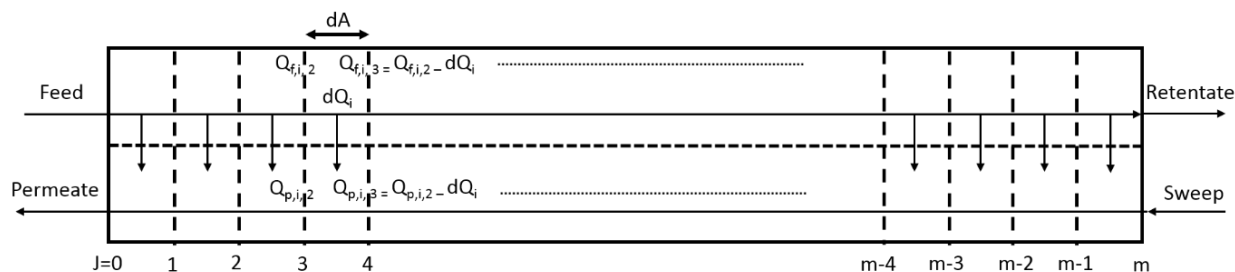

Fig. 2. Counter-current gas flow configuration through a membrane [28].

The membrane was divided into  $m$  equal area, perfectly mixed stages. Assuming a dense, asymmetric membrane, the mole flux for each component,  $i$ , on the feed side is given by:

$$dQ_{f,i} = P_i \cdot (P_f \cdot x_{i,f} - P_p \cdot y_{i,p}) \cdot dA \quad (1)$$

where  $Q_{f,i}$  is the molar flow of  $i$  in the feed,  $P_i$  is the permeance for  $i$ ,  $P_f$  is the feed side pressure,  $P_p$  is the permeate pressure,  $x_{i,f}$  is the molar fraction of  $i$  in the feed side increment,  $y_{i,p}$  is the molar fraction of  $i$  in the permeate side increment and  $A$  is the membrane area.

The counter-current configuration is complicated to solve because a concentration profile exists on the permeate side and the permeate exit flows at  $j=0$  are unknown. An initial estimate for the concentration profile is needed to solve the set of non-linear differential equations. Since the permeate and feed flows are in opposite directions, equation (2) may be stated:

$$dQ_{f,i,j} = dQ_{p,i,j} \quad (2)$$

Instead of requiring an initial estimate of the steady-state concentration profile, this model solves a total permeate pressure of zero in the first iteration, for which the solution of the mole balance equation (1) is insignificant (the value of the second term in parentheses is zero). The permeate pressure is then increased by an increment. The concentration profile generated in the first iteration is used to solve the system in the second iteration. In this manner, the permeate pressure is increased until the actual (steady state) permeate pressure is reached, with small enough increments that the concentration profiles change slightly with each increment. The method is analogous to starting up a membrane module with full vacuum on the permeate side and allowing the pressure to rise by throttling the outflow of permeate. The model uses fourth-order Runge-Kutta method to calculate the flux along membrane length and then uses iterations over permeate values to converge to a solution.

## 2.2. Membrane selection

He concentration in natural gas varies significantly from one source to another. The concentration of He from different reservoirs around the world is presented in Table 1.

Table 1  
Composition of He from different gas fields [29].

	AUSTRALIA	POLAND	CANADA	TEXAS, USA	NEW MEXICO, USA
CH <sub>4</sub>	97.5	56	93	66	49
CO <sub>2</sub>	0.10	0.30	0.50	0.10	0.90
N <sub>2</sub>	2.30	43	6	31	45
HE	0.21	0.40	0.53	1.17	4.05

A He recovery membrane needs to separate He from CH<sub>4</sub> as well as from N<sub>2</sub> at high pressure. Conventional polymeric membranes lack tensile strength and experience problems like compaction and rupture. Inorganic membranes, on the other hand, have high strength and can withstand large pressure differences across the membrane. In this work, two inorganic and one

polymeric membrane were selected. The He permeability and selectivity (He/CH<sub>4</sub> and He/N<sub>2</sub>) of these membranes are presented in Table 2.

Table 2  
Membrane properties used in this work.

Membrane	Permeability (Barrer)			Selectivity		Wall thickness (μm)	Reference
	He	CH <sub>4</sub>	N <sub>2</sub>	He/CH <sub>4</sub>	He/N <sub>2</sub>		
Matrimid	26	0.21	0.28	124	93	10	[21]
CMS	281	0.095	0.80	2954	350	20	[22, 30]
Porous silica	800	0.069	3.40	11675	235	10	[31]

The gas permeation properties of the inorganic membranes are above Robeson upper bound for He/CH<sub>4</sub> and He/N<sub>2</sub> separation as shown in Figure 3(a) and (b).

Both inorganic membranes used in this work has high He/CH<sub>4</sub> selectivity and permeability. The porous silica membrane reported in the literature was tested for adsorption and permeability of different gases. The selectivity of the membrane was higher than Knudsen selectivity hence, diffusion of gas through a porous media was not solely the driving mechanism. Interaction of diffusing gases with pore walls might have added to increase the separation performance of the membrane. The selectivity was also found to decrease with increase in temperature [19]. These silica membranes have poor mechanical stability and the surface is susceptible to all kind of reactions at elevated temperature with feed components, hence, surface modification is required [32].

Natural gas is a mixture of CH<sub>4</sub> and higher hydrocarbons. The feed gas for this plant is considered after acid gas removal, dehydration, and higher hydrocarbon removal. Higher hydrocarbons like ethane, propane, and butane are known to show adverse effects on membrane processes over the period of time. At such high pressure, even a small fraction of higher hydrocarbons entering the membrane module can result in a decline in membrane performance over a period of time.

## 2.3. Membrane configuration

### 2.3.1. Single stage membrane process

A membrane separation unit can be characterized by the number of membrane stages. The simplest of all is a single stage membrane unit operation where feed gas passes through only one membrane module to produce He rich permeate (product) and a retentate (reject) stream as illustrated in Figure 4(a).

### 2.3.2. Two-stage membrane process

A single stage membrane unit (with reported membrane performance as in Table 2) is not efficient enough to achieve high purity and desired recovery of He for all membranes. Thus, a multi-stage membrane separation system was simulated in this work to produce high-quality He. The schematic diagram of a two-stage He recovery system where the permeate from the first stage was further purified by the second membrane to produce high-quality He (97%) at high recovery (90%) is presented in Figure 4(b). The permeate 1 is obtained at 1 bar which is further recompressed to 71 bar (feed for 2<sup>nd</sup> stage) before entering the second stage. The retentate stream of stage 1 and stage two are at 70 bar and rich with CH<sub>4</sub> thus, returned to the natural gas

pipeline. The Matrimid membrane has the lowest performance among all three membranes that are considered here. A two-stage system without recycle stream cannot achieve the desired purity and recovery of He therefore, a two-stage process with recycle stream is also simulated for Matrimid membrane. The process configuration of a two-stage process with recycle is presented in Figure 4(c).

#### 2.4. Process conditions and simulation basis

A natural gas stream of 400Nm<sup>3</sup>/h at 70 bar (after acid gas removal, dehydration and mercury removal) was considered in this work. Two sets of simulations were conducted involving different concentrations of He, CH<sub>4</sub> and N<sub>2</sub> in the gas mixture to determine the optimal membrane area and energy required to achieve 97% pure He with less than 10% He loss. The details of process conditions are tabulated in Table 3.

The feed gas is considered at 70 bar pressure which is obtained directly from the pipeline. While simulating a two-stage system, permeate from the first stage is compressed to 71 bar and then fed to second stage membrane. In case of no recycle, the retentate streams at 70 bar from the first and second stage are sent back to CH<sub>4</sub> stream (pipeline) which is already at 70bar.

#### 2.5. Cost estimation

The economic assessment of a membrane-based plant depends on the method of analysis and assumptions that are used to evaluate the total capital investment and production cost. Therefore, economic evaluation performed by different methods may vary. However, such differences can be informative if the methodology used in the economic evaluations is clearly described. In this economic assessment, membrane area and required energy (compressor) for separation process are considered as a major part of the total capital investment (TCI) and the production cost (PC) of the separation plant. Predicting the cost of inorganic membrane modules (CMS and silica) and life of the membranes is challenging due to the lack of commercial precedent. The expected membrane life time is considered as 5 years. However, based on a pilot scale demonstration of CMS at biogas plant [33], it was observed that some of the CMS modules may experience fiber breakage (due to vibration or handling/shipping of the modules) and therefore, cannot be used until repaired. Again, other modules may perform well for a longer time. Therefore, the first-time installation of membrane modules was included in the TCI. However, membrane replacement cost (MRC) was obtained by dividing the total membrane cost with membrane life to calculate annual usage and then added it in the PC. The factors and assumptions used to calculate the cost and net present value (NPV) are shown in Table 4. Feed flow rate is 400 Nm<sup>3</sup>/hr.

### 3. Results and discussion

#### 3.1. Single stage membrane system

##### 3.1.1. Separation from CH<sub>4</sub>

As mentioned earlier, the composition of natural gas varies significantly from one source to another. One scenario where natural gas contains He and CH<sub>4</sub> with a negligible amount of N<sub>2</sub> was considered in the first set of simulations. The feed gas at 70 bar containing different feed concentrations of He (1-5%) in CH<sub>4</sub> was considered to achieve 97% purity and 90% recovery of He in a single stage process. The simulation results showed that due to high membrane performance, only microporous silica can achieve the desired purity and recovery in a single stage process when no recycle stream is used. The gas permeation properties also for CMS are above Robeson upper bound for He/CH<sub>4</sub> gas pair. But it is not possible for CMS to obtain simultaneously high purity and recovery in a single stage process. As shown in Figure 5, the maximum achievable purity is 65% when 1% He is present in the feed gas and recovery is only 0.04% for this purity. The permeate purity of He is controlled by partial pressure of He while 1-2% He is present in the feed gas. As soon as the He loadings in the feed increase to 3% or higher, the effect of the partial pressure of He in the feed diminishes and purity is governed by He/CH<sub>4</sub> selectivity and remains almost same for the applied conditions. The He purity of 97% with maximum recovery of 72% can be achieved in a single stage process with CMS when 5% He is present in the feed.

The permeation properties of Matrimid membrane are lower than CMS and lies below Robeson upper bound. The maximum purity achieved with Matrimid membrane is 83% when 5% He is present in the feed. These simulation results indicate that the permeate purity is significantly affected by the partial pressure of He in the feed gas for all He loadings while using Matrimid membrane, which specifies that permeate purity lies in the pressure-

ratio dependent region and not in the selectivity driven region. That is why the difference in the obtained purity is significant for different loadings of He in the feed gas. The maximum purity is 83% when 5% He is present in the feed however; the minimum purity value of 37% is obtained when 1% He is present in the feed gas.

**Table 3**  
Process conditions used in simulations.

Feed composition, 1st set	1-5 % He, balance CH <sub>4</sub>
Feed composition, 2 <sup>nd</sup> set	1-5% He, 45% N <sub>2</sub> , balance CH <sub>4</sub>
Feed flow rate (Nm <sup>3</sup> /hr)	400
He purity in the product (%)	97
He loss (%)	less than 10
Feed pressure, P <sub>f</sub> (bar)	70
Permeate pressure, P <sub>p</sub> (bar)	1
Pressure at the inlet of stage-2, P <sub>2</sub> (bar)	71
Temperature, T (°C)	25
Flow pattern in membrane module	Countercurrent
Adiabatic efficiency of the compressor (%)	75

**Table 4**  
Economic parameters [34-36].

Process parameters for economic assessment of He recovery plant	
Total plant investment (TPI)	Values/factors
Polymeric membrane cost (PMC)/ Matrimid	\$50/m <sup>2</sup>
Inorganic membrane cost (IMC)/ carbon/ silica	\$100/m <sup>2</sup>
Installed compressor cost (CC)	\$ 8700 X (HP) <sup>0.82</sup>
Fixed cost (FC)	PMC/IMC + CC
<i>Installation multiplier</i>	
Membrane skid	1.85
Compressor skid	1.6
Project contingency	20%
<i>Annual variable operating and maintenance cost (VOM)</i>	
Membrane replacement cost (MRC)	replacement cost/year
Utility cost (UC) (\$/kWh)	0.07/kWh
VOM	MRC + UC + PC
Process contingency (C <sub>p</sub> )	20%
Production cost (PC)	VOM + C <sub>p</sub>
<i>Other assumptions</i>	
Membrane life for Matrimid	7.5 years
Membrane life for inorganic membranes	5 years
He sales price (\$)	1.87/Nm <sup>3</sup>
He recovery (%)	90
Nominal interest rate (%)	6%
Depreciation for the plant except for membranes	15 years
LCC/LCI factor (Ordinary annuity factor)	9.7122
Plant availability (%)	96%

<sup>a</sup>HP is the installed horsepower for the installed compressor

<sup>b</sup>Life cycle cost

<sup>c</sup>Life cycle inventory

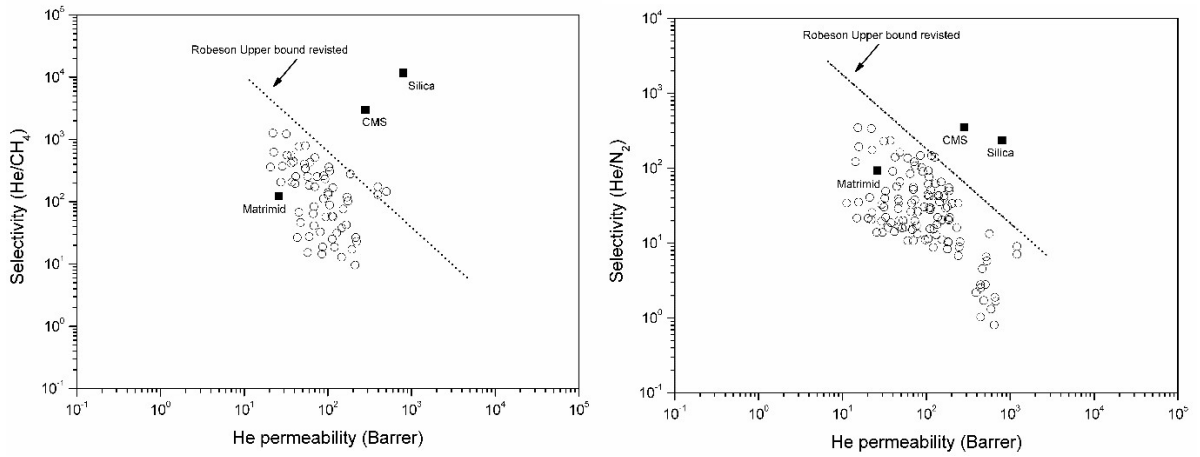

Fig. 3. CMS, Porous Silica, and Matrimid membranes on Robeson plot (a) for He/CH<sub>4</sub> separation, (b) for He/N<sub>2</sub> separation: adopted from [8].

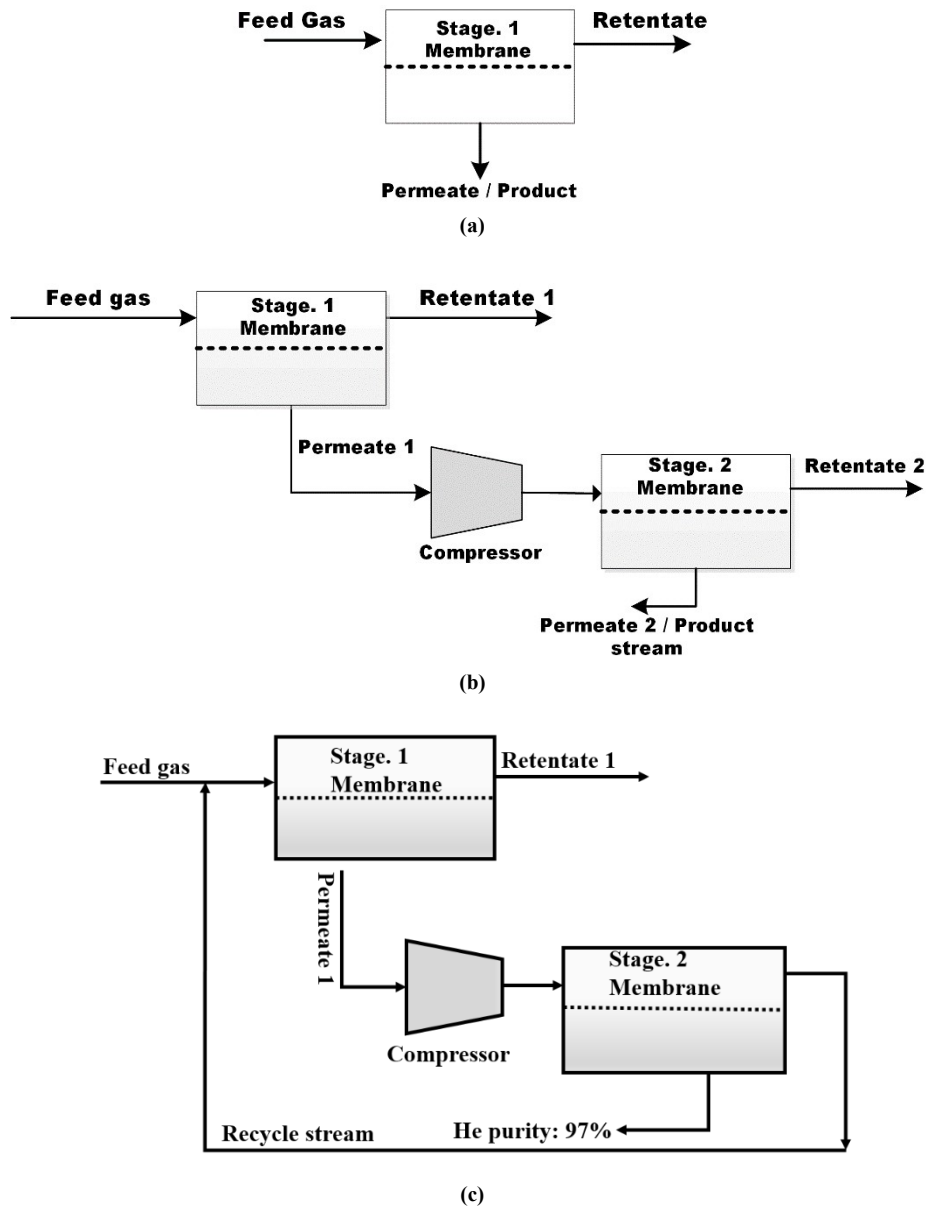

Fig. 4. (a) Single stage membrane unit for gas separation, (b): Two-stage membrane unit for gas separation with interstage pressure booster, and (c): Two-stage membrane unit for gas separation with interstage pressure booster and a recycle stream.



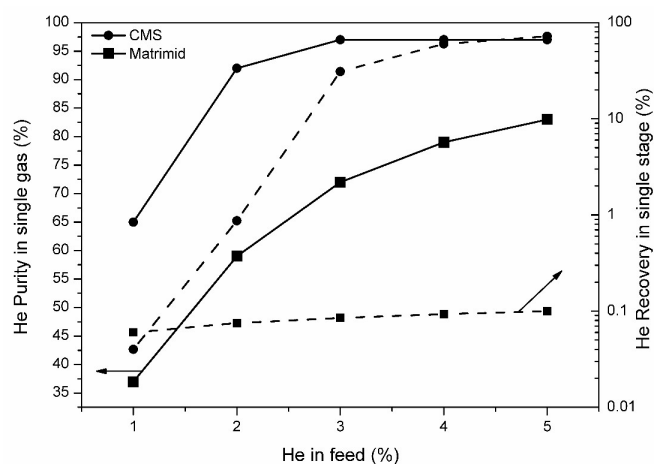

Fig. 5. He purity (%) and maximum recovery (%) (Logarithmic scale) obtained in a single stage separation process for CMS and Matrimid (recovery for Matrimid: 1%);  $P_1$ : 70 bar,  $T$ : 25°C.

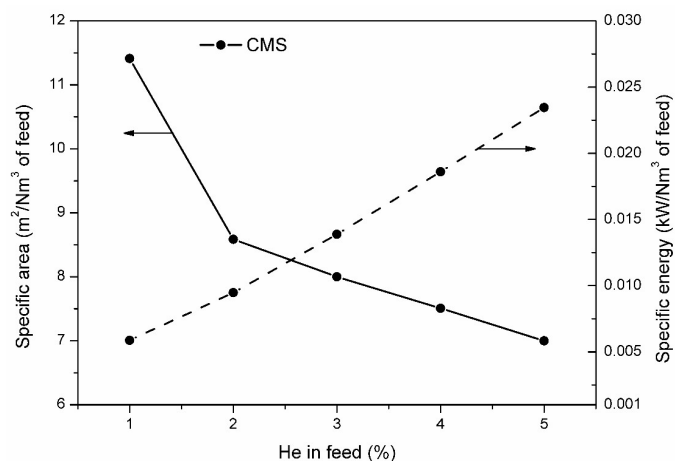

Fig. 6. Specific area ( $\text{m}^2/\text{Nm}^3$  of feed gas) and specific energy ( $\text{kW}/\text{Nm}^3$  of feed gas) when separating from  $\text{CH}_4$  with CMS; Two-stage with no recycle,  $P_1$ : 70 bar,  $P_2$ : 71 bar,  $T$ : 25°C.

### 3.2. He recovery using a two-stage membrane system

As discussed earlier, a single stage process is not sufficient to achieve the desired purity (97%) and recovery (90%) of He when partial pressure of He is 1-5% in the feed gas at given conditions for CMS and Matrimid membranes. Therefore, a two-stage membrane system with and without recycle stream was investigated to achieve the desired set of purity and recovery. As silica membrane can achieve the desired purity and recovery in a single stage, hence it is not considered in this section.

#### 3.2.1. Separation from $\text{CH}_4$

First, a two-stage process with no recycle stream was simulated applying different concentrations of He (1-5%) in  $\text{CH}_4$  to determine the optimal membrane area required to achieve 97% pure He at 90% recovery. From a feed stream at 70 bar entering the first module, a He-rich permeate was produced at 1 bar pressure and  $\text{CH}_4$ -rich retentate. The permeate of stage 1 was compressed to 71 bar by inter-stage compressor as shown in Figure 4(b). The membrane specific surface area for CMS was determined for each concentration of He in the feed gas. The specific energy requirement for the inter-stage compressor was also obtained through simulations. Figure 6 presents the specific membrane area and specific energy for CMS at different feed concentrations of "He".

As could be observed in Figure 6, the specific surface area of the membrane decreases with increase in He concentration in the feed stream. As the He concentration increases in the feed, the partial pressure of He across membrane increases hence resulting in higher flux and greater driving force for mass transfer. The required area per  $\text{Nm}^3$  of feed gas is lowest when 5% He is present in the feed and this is according to the Fick's law.

The energy demand for CMS increases with respect to the He loadings in the feed gas because the inter-stage compressor has to handle a larger volume of gas to achieve the desired purity and recovery in second stage. The purity and recovery of He in the first stage is not up to the required specifications (also shown in Figure 5) which resulted in a higher volume of gas needed to be compressed for the second stage to achieve desired purity and recovery of He. This increased volume of gas caused higher energy demand for compression.

Figure 7 indicates that Matrimid cannot achieve the desired set of purity and recovery in two stage process when He in the feed stream is 1-3% and no recycle stream is present. However, the Matrimid membrane can obtain the required purity and recovery when 4 or higher mol% of He is present in the feed. While simulating two stage process without recycle stream, the purity in permeate 2 was set to 97%. Therefore, the recovery values in Figure 7 are the maximum recovery obtained at that concentration of He in the feed gas. From Figure 6 and 7, CMS and Matrimid can be compared for only two concentration values (Matrimid can achieve desired set of purity and recovery for only two values) of He in the feed gas; 4% and 5%. Although Matrimid lies well below Robeson upper bound yet the membrane area required for Matrimid is only 15% higher compared to CMS when 4% He is present in the feed gas. This small difference in membrane area can be explained with two reasons; first reason is the increased permeance of Matrimid due to thinner wall thickness (10  $\mu\text{m}$ ), and secondly, the required purity and recovery is governed by pressure-ratio region which is also optimizing the membrane area towards the desired product purity and recovery.

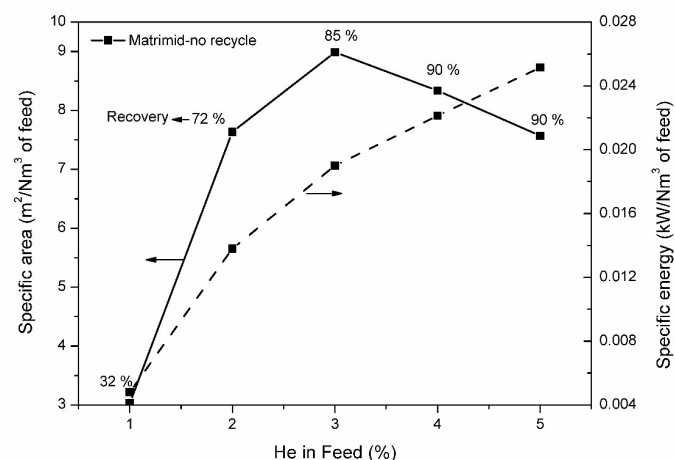

Fig. 7. Specific area ( $\text{m}^2/\text{Nm}^3$  of feed gas) and specific energy ( $\text{kW}/\text{Nm}^3$  of feed gas) when separating from  $\text{CH}_4$  with Matrimid; Two-stage with no recycle,  $P_1$ : 70 bar,  $P_2$ : 71 bar,  $T$ : 25°C.

This effect is clearer when 5% He is present in the feed gas while separating with Matrimid membranes. Due to higher partial pressure of He (5%), the required membrane area reduces by 15% compared to the area for 4% He in the feed gas. However, in case of CMS the first stage is governed by He/ $\text{CH}_4$  selectivity and maximum purity and recovery is achieved in first stage at cost of higher membrane area and second stage is used to achieve the desired specifications of purity and recovery. This difference in membrane area for two membranes reduces to 10% when He concentration in the feed increases to 5%. Similarly, the required energy of inter-stage compressor is 15% higher for Matrimid membrane as compared to CMS when 4% He is in the feed gas. Because of lower He/ $\text{CH}_4$  selectivity of Matrimid, it produces a high volume of permeate with a lower concentration of He (54%) in the first stage to achieve 90% recovery. This high volume is then compressed for further purification in the second stage to achieve 97% purity and 90% recovery. Thus, it requires higher compression energy to treat this volume. This difference in energy reduces to 7% when 5% He is present in the feed. Increase in partial pressure of He produces He rich permeate with smaller gas volume in the first stage (Matrimid) which ultimately lower the energy requirement for inter-stage compression.

Figure 7 shows that lower He/ $\text{CH}_4$  selectivity of Matrimid membrane does not allow it to achieve 97% purity and 90% recovery of He at the same time even in two stage process when no recycle stream is used. Therefore, two stage process with a recycle stream has been investigated for Matrimid membrane to reach the desired purity and recovery of He.

The simulation results showed that it is possible to achieve the required specification of purity and recovery while using a two-stage process with a

recycle stream for Matrimid membranes. Figure 8 presents the required specific membrane area and energy for this process. It can be seen that the two-stage process with recycle requires much higher specific energy compared to the two-stage with no recycle stream for CMS (see Figure 6). This difference in energy is 36% when 1% He is present in the feed gas. However, two stage process with recycle stream for Matrimid requires 76% higher energy compared to CMS when 3% He is present in the feed gas. This higher energy is due to the addition of recycle stream which also would require a compressor with larger capacity. Hence, it would affect both the capital investment and production cost of the process.

### 3.2.2. Separation from the natural gas mixture

Usually He-rich natural gas contains a significant amount of  $N_2$  as presented in Table 1. Simulations were performed to study the separation of He from natural gas containing 45%  $N_2$ , 1-5% He and rest  $CH_4$ . The two-stage membrane system was designed to produce 97% pure He with 90% recovery. Figure 9 presents the required specific area and energy of inter-stage compressor from the two-stage membrane system when no recycle stream is used while He is separated from the natural gas mixture using silica or CMS membrane.

For both silica and CMS membranes, it was possible to achieve the goal of high purity and recovery at all concentrations of He in the feed stream while using a two-stage system without recycle stream. However, the membrane area and energy demand varied significantly for these membranes. At lowest concentration of He (1%), the membrane surface area of porous silica was smaller compared to CMS due to its high permeance however, the specific energy demand for silica was higher at the same conditions. Due to the high permeance and lower selectivity (He/ $N_2$ ), porous silica produces a high volume of permeate in the first stage to achieve 90% recovery. This high volume is then compressed for further purification in the second stage to achieve 97% purity. However, CMS have higher selectivity (He/ $N_2$ ) than porous silica and it produces a He-rich permeate in the first stage which is smaller in volume and hence results in lower energy consumption for the inter-stage compression. The specific energy demand for CMS is approximately 20% lesser than that of porous silica when 1% He is present in the feed gas. With respect to increasing He feed concentration, the specific energy demand also increases for both membranes but the difference in energy requirement for silica and CMS decreases. At high concentration of He (5%), the porous silica requires only 3% more energy than CMS.

The specific membrane area, on the other hand, is smallest for porous silica due to its high permeance. When compared to CMS, porous silica requires around six times smaller area to achieve same purity and recovery. This results in smaller module size and / or fewer modules and eventually lower capital investment.

Figure 10 presents the specific area and energy as a function of He loadings in the feed while using Matrimid membrane in a two-stage process without recycle. Again, the lower performance of Matrimid inhibits to accomplish the desired purity and recovery for lower loadings (1-4%) of He in the feed while using two stage process without recycle stream. Therefore, a recycle stream is required to achieve the required target of purity and recovery. The Matrimid can only obtain 97% purity and 90% recovery when feed concentration of He is 5%. The energy requirement is 15% higher for Matrimid and area is 4 times larger as compared to CMS in this case. Nevertheless, porous silica offers 13% lower energy and 27 times lesser area compared to Matrimid when 5% He is present in the feed gas.

Figure 11 presents the results of two stage process with recycle stream while separating with Matrimid membrane. It can be seen that adding a recycle stream increases both energy requirement and membrane area to achieve the desired purity and recovery of He with Matrimid membranes. The energy demand, in this case, is 60% higher compared to CMS when 1% He is present in the feed. This difference decreases to 20% when feed concentration of He is 4%. However, the required membrane area is 16 times higher compared to silica membrane and 3 times in comparison with CMS.

As shown in Figure 11, the energy requirement for Matrimid seems to be optimized towards the required purity and recovery therefore, the difference in energy demand is minor (up to 3%) when feed concentration of He is between 1-3%. However, the effect of partial pressure of He is much larger when feed concentration of He is 4% because more volume of gas is being recycled to achieve the target of purity and recovery hence, high capacity compressor is needed. The area is largest when feed concentration of He is 1% and almost 30% area reduction is obtained when He in the feed increases to 4%.

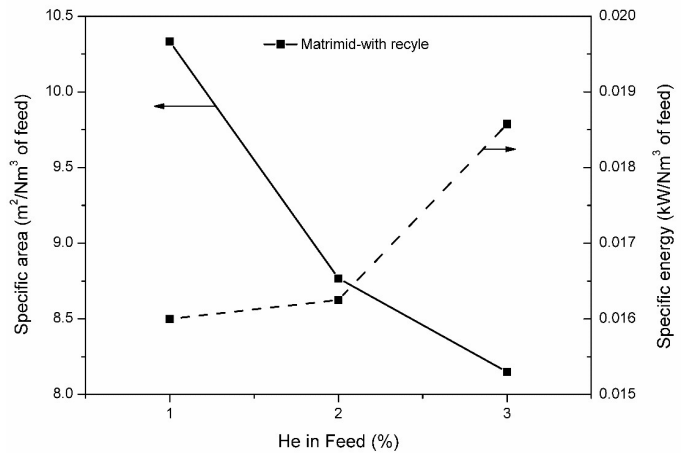

Fig. 8. Specific area ( $m^2/Nm^3$  of feed gas) and specific energy ( $kW/Nm^3$  of feed gas) when separating from  $CH_4$  with Matrimid; Two-stage with recycle,  $P_1$ : 70 bar,  $P_2$ : 71 bar, T: 25°C.

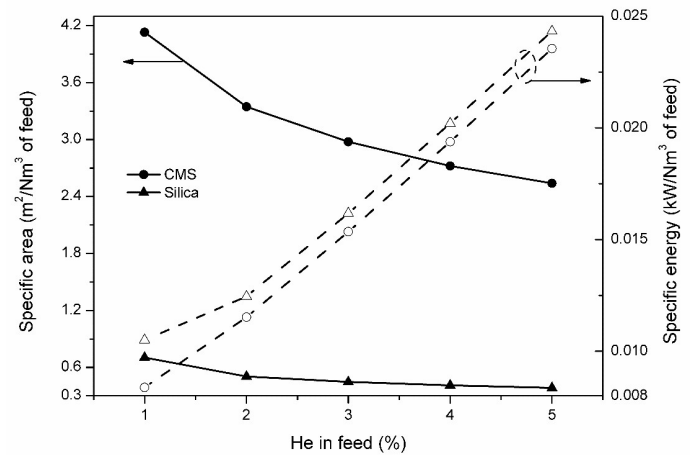

Fig. 9. Specific area ( $m^2/Nm^3$  of feed gas) and specific energy ( $kW/Nm^3$  of feed gas) when separating from the natural gas mixture; Two-stage with no recycle,  $P_1$ : 70 bar,  $P_2$ : 71 bar, T: 25°C.

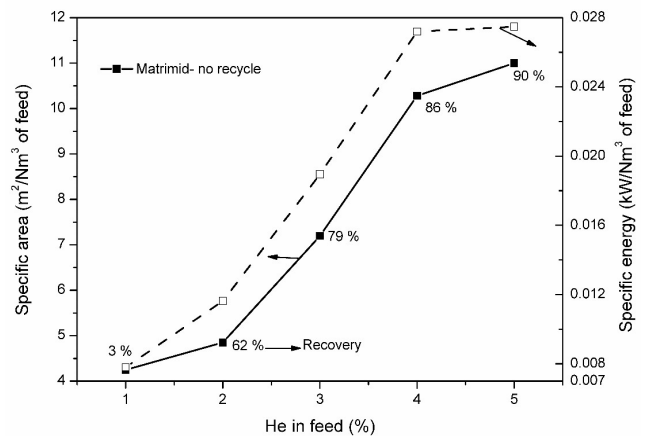

Fig. 10. Specific area ( $m^2/Nm^3$  of feed gas) and specific energy ( $kW/Nm^3$  of feed gas) when separating from the natural gas mixture with Matrimid; Two-stage with no recycle,  $P_1$ : 70 bar,  $P_2$ : 71 bar, T: 25°C.

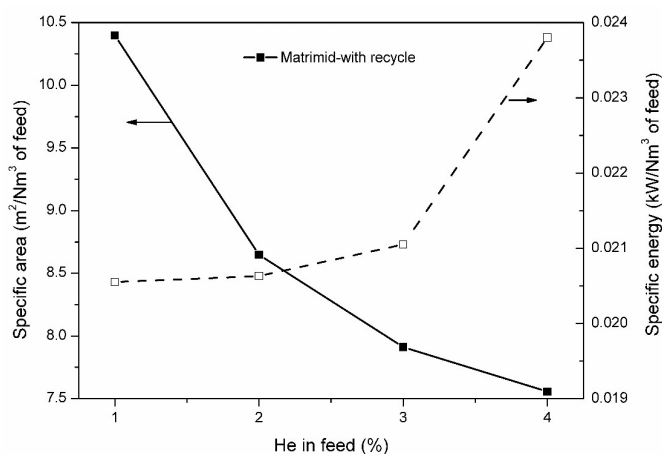

Figure 11: Specific area ( $\text{m}^2/\text{Nm}^3$  of feed gas) and specific energy ( $\text{kW}/\text{Nm}^3$  of feed gas) when separating from the natural gas mixture with Matrimid; Two-stage with recycle,  $P_1$ : 70 bar,  $P_2$ : 71 bar,  $T$ : 25°C.

### 3.3. Cost estimation

#### 3.3.1. Separation from $\text{CH}_4$

The total capital investment (TCI) of the plant was calculated based on required membrane area and cost of the installed compressor whereas the specific production cost (PC) was estimated based on energy demand, membrane replacement cost, and project contingency per normal cubic meter of produced He. The net present value (NPV) for each plant was also calculated based on the assumptions presented in Table 4.

Since silica has the highest separation performance, a single stage process with low ( $<100 \text{ m}^2$ ) membrane area may achieve the required values of purity and recovery while separating He from  $\text{CH}_4$ . However, two stage process are needed for CMS and Matrimid membranes. The TCI and PC for silica based single stage process is very low and is not presented in form of figures here. The only comparison of CMS and Matrimid is discussed in this section. Figure 12 is showing the TCI, PC, and NPV for CMS membrane-based plant as a function of He loadings in the feed gas mixture for a two-stage membrane system when no recycle stream is used. The lowest PC  $\$ 0.47/\text{Nm}^3$  of produced He is achieved when 5% He is present in the feed gas, and the TCI for this plant is 1.2 million dollars. The payback time is about five years when membrane cost  $\$100/\text{m}^2$  and membrane life of 5 years is considered. Figure 12 also shows that NPV for this plant is positive only when feed concentration of He is 4% or higher. Therefore, this plant is only feasible for high concentration (4-5%) of He in the feed.

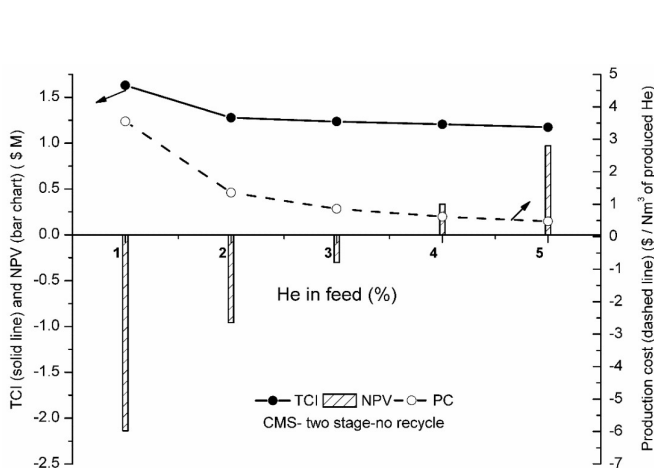

Figure 12: TCI, PC, and NPV as function of He (%) in the feed when separating He from  $\text{CH}_4$  with CMS; two-stage with no recycle,  $P_1$ : 70 bar,  $P_2$ : 71 bar,  $T$ : 25°C.

Figure 13 presents the cost of two stage process for Matrimid membrane when no recycle stream is used. It is important to note that this process cannot

achieve desired recovery of 90% for all the considered concentrations of He in the feed gas (as shown in Figure 7). The required purity and recovery are achieved only when He in the feed stream is 4-5%. Although the maximum recovery achieved is 86% when 3% He is present in the feed yet the NPV for this plant is positive with almost five years of payback time. This is due to low cost of polymeric membrane ( $\$50/\text{m}^2$ ) and presumed longer life (7.5 years) compared to inorganic membranes. However, the lowest TCI  $\$ 746,000$  and PC  $\$ 0.20/\text{Nm}^3$  of produced gas are obtained when 5% He is present in the feed gas and NPV for this plant is  $\$ \text{M } 1.8$ .

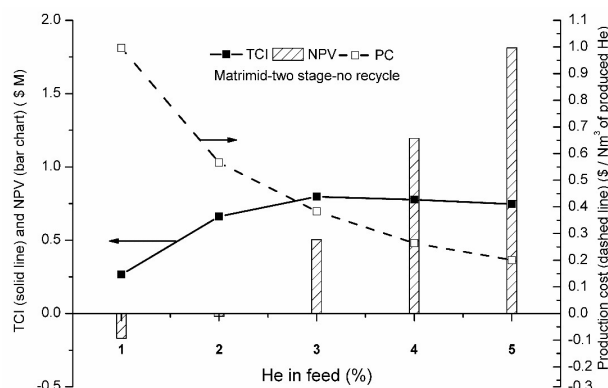

Figure 13: TCI, PC, and NPV as function of He (%) in the feed when separating He from  $\text{CH}_4$  with Matrimid; two-stage with no recycle,  $P_1$ : 70 bar,  $P_2$ : 71 bar,  $T$ : 25°C.

Figure 14 is showing the cost of Matrimid based plant when two stage process with recycle stream is used to separate He from  $\text{CH}_4$ . While the desired set of purity and recovery is attained with recycle stream, still the NPV for this plant is negative when 1% He is present in the feed. The membrane area is largest at this point and installed compressor with larger capacity is required due to the recycle stream. Both membrane area and larger compressor increase the TCI of the plant, and the energy requirement also increases due to recycle stream which adds into PC. However, the profit is lowest because only 1% He is present in the feed hence, the plant is not feasible. The NPV is positive for the plant when He concentration is 2 mole% or higher in the feed gas. Nonetheless, the lowest TCI  $\$ 736,000$  and PC  $\$ 0.33/\text{Nm}^3$  of produced gas are obtained when 3% He is present in the feed gas. The NPV for this plant is  $\$670,000$ .

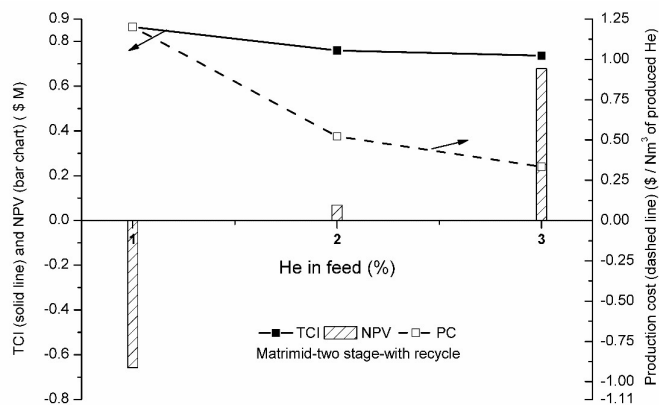

Figure 14: TCI, PC, and NPV as function of He (%) in the feed when separating He from  $\text{CH}_4$  with Matrimid; two-stage with recycle,  $P_1$ : 70 bar,  $P_2$ : 71 bar,  $T$ : 25°C.

#### 3.3.2. Separation from the natural gas mixture

Figure 15 shows the TCI, PC, and NPV for a silica membrane-based plant as a function of He loadings in the feed gas while separating using a two-stage process with no recycle stream. The simulation results and NPV indicate that a plant with silica membrane is profitable for all (1-5%)



concentrations of He in the feed. Despite the high cost \$ 100/m<sup>2</sup> and shorter life time compared to polymeric membranes, the high performance (He permeability and He/CH<sub>4</sub>, He/N<sub>2</sub> selectivity) of silica membrane cuts the TCI and PC to a very low value for all He loadings in the feed. The lowest concentration of He (1%) in the feed gives NPV of 250,000 with a payback time of 4.5 years. The effect of membrane area on TCI is highest when 1% He is present in the feed gas; however, this effect is less significant for feed concentration of 2-5%. Therefore, the cost of membrane area is not affecting TCI significantly for all loadings of He between 2 and 5%. However, the change in PC is mainly due to inter-stage compression cost which is maximum for lowest feed concentration of "He". The PC per Nm<sup>3</sup> of produced He for the silica-based plant reduces by more than 80% when 5% He is present in the feed gas. The NPV for this plant is \$M 2.5 with a payback time of eleven months when 5% He is present in the feed gas however; the TCI and PC for this plant are \$ 275,000 and \$ 0.07/Nm<sup>3</sup> of produced He.

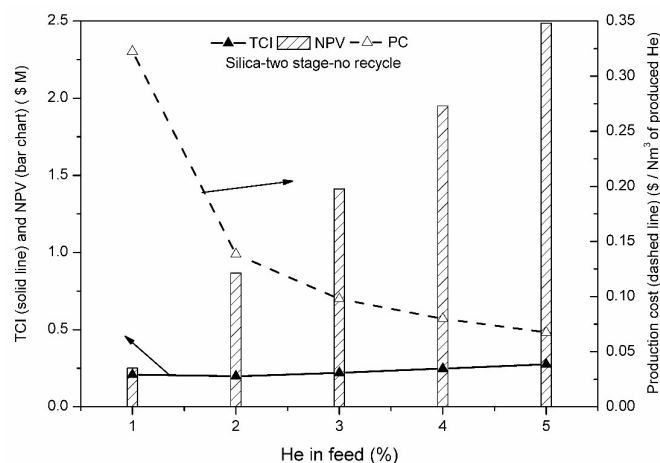

Fig. 15. TCI, PC, and NPV as function of He (%) in the feed when separating He from natural gas mixture with silica; two-stage with no recycle,  $P_1$ : 70 bar,  $P_2$ : 71 bar, T: 25°C.

Compared to silica membrane, CMS offers negative NPV for the lowest feed concentration of He in the feed as shown in Figure 16. The TCI and PC of CMS are highest when 1% He is present in the feed and it is due to larger membrane area requirement in this case. As discussed previously considering Figure 6, CMS requires almost 6 times larger membrane area compared to silica, and it is because of much lesser He permeance and He/CH<sub>4</sub> selectivity compared to silica membrane. In addition, the cost \$ 100/m<sup>2</sup> and life time (5 years) affects the TCI and PC significantly. The NPV is positive for CMS based plant when feed concentration of He is 2 mole% or higher. The PC per Nm<sup>3</sup> of produced He for the CMS-based plant reduces by 85% when 5% He is present in the feed gas. The NPV for this plant is \$M 2 with a payback time of one year when 5% He is present in the feed gas however; the TCI and PC for this plant are \$ 560,000 and \$ 0.20/Nm<sup>3</sup> of produced He.

Figure 17 shows the TCI, PC, and NPV for a Matrimid membrane-based plant as a function of He loadings in the feed gas while separating in a two-stage process with no recycle stream. The simulation results and NPV indicate that a plant with Matrimid membrane is not profitable for lowest concentration (1%) of He in the feed. It is important to note that, the desired recovery of 90% is only achieved when He in the feed stream is 5%. Although the recovery is 86% when 2% He is present in the feed yet the NPV for this plant is positive with 7.5 years of payback time. The TCI and PC for this plant are \$450,000 and \$0.44/Nm<sup>3</sup> of produced He. Again, the effect of low cost and longer life of polymeric membrane can be seen here. These results indicate that a plant with Matrimid membrane is feasible and profitable for feed concentration of 2-5% in natural gas if He loss of up to 40% is acceptable for the investors.

Figure 18 presents the cost and NPV for a Matrimid based plant as a function of He loadings in the feed gas while separation is performed using a two-stage system with recycle stream. The highest TCI and PC values were obtained at 1% feed concentration of He. This is due to the large membrane area usage and high energy requirement for the inter-stage compressor. The lower permeance of Matrimid membrane compared to CMS resulted in

almost three times larger membrane area and 60% higher energy for inter-stage pressure when recycle stream was simulated. The recirculation of gas results in higher volume and a larger compressor is needed to treat the gas which ultimately increases the TCI. However, the energy demand for high volume of gas increases the production cost significantly. By utilizing large membrane area and energy, the goal of 90% He recovery with 97% purity can be achieved with recycle stream but the TCI increased to \$M 0.9 resulting in a negative NPV value. This indicates that a plant operating with Matrimid will have a negative profit at 1% feed concentrations of He in the feed gas. The NPV is positive for Matrimid based plant while using recycle stream when feed concentration of He is 2 or higher mol%. The PC per Nm<sup>3</sup> of produced He for the Matrimid-based plant was 80% when 4% He is present in the feed gas. The NPV for this plant is \$M 1.2 with a payback time of 3.5 years when 4% He is present in the feed gas and recycle is used to achieve the desired purity and recovery. However; the TCI and PC for this plant are \$ 735,000 and \$ 0.25/Nm<sup>3</sup> of produced He.

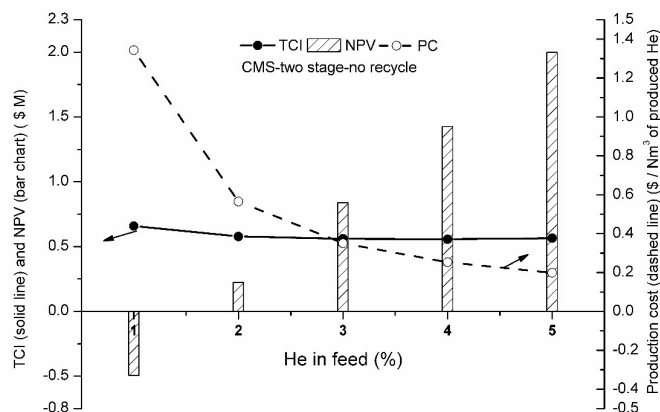

Fig. 16. TCI, PC, and NPV as function of He (%) in the feed when separating He from natural gas mixture with CMS; two-stage with no recycle,  $P_1$ : 70 bar,  $P_2$ : 71 bar, T: 25°C.

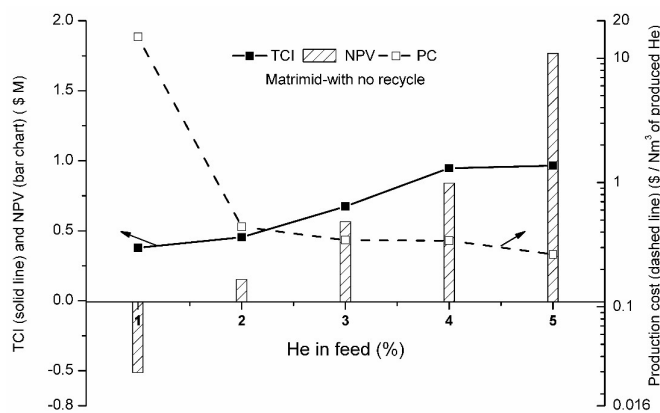

Fig. 17. TCI, PC, and NPV as function of He (%) in the feed when separating He from natural gas mixture with Matrimid; two-stage with no recycle,  $P_1$ : 70 bar,  $P_2$ : 71 bar, T: 25°C.

#### 4. Conclusions

Gas separation membranes, especially inorganic membranes, have a large potential for the practical application in large-scale separation of He from the natural gas stream. Three different membranes (two inorganic and one polymeric) were simulated to obtain simultaneously both high purity (97 mole%) and recovery (90%) of He when separated from the natural gas stream. It was determined that inorganic porous silica, CMS, and Matrimid

membranes have a nice potential for large-scale He separation application depending on the feed composition of the natural gas.

The composition of natural gas varies significantly from one source to another. One scenario where natural gas contains He and CH<sub>4</sub> with a negligible amount of N<sub>2</sub> was considered in the first set of simulations.

Microporous silica has the highest separation performance and a single stage process with low (<100 m<sup>2</sup>) membrane area may achieve the required values of purity and recovery while separating He from CH<sub>4</sub>. However, two stage process is needed for CMS and Matrimid membranes.

More simulations were performed to study the separation of He from natural gas containing 45% N<sub>2</sub>, 1-5% He and rest CH<sub>4</sub>. In a two-stage process with interstage compressor, all three membranes were able to achieve 97% purity and 90% recovery of He. However, Matrimid required a recycle stream and the largest membrane area was needed due to low permeance of He compared to CMS and porous silica. Table 5 presents the summary of the results obtained while separating He from natural gas using different membrane technologies.

As shown in Table 5, among the three investigated membranes, the porous silica had the highest efficient recovery of He from a mixture of gases containing CH<sub>4</sub> and N<sub>2</sub> followed by CMS and Matrimid. A two-stage process with recycle is required to achieve the desired purity and recovery while separating with Matrimid. The recycle stream makes the process more complex and costlier. The system is easy to operate when no recycle stream is present.

It can be stated that despite the high cost \$ 100/m<sup>2</sup> and shorter life time of silica and CMS membranes compared to Matrimid membrane, the high performance (He permeability and He/CH<sub>4</sub>, He/N<sub>2</sub> selectivity) of silica and CMS cuts the TCI and PC to an economically viable range for different loadings of He in the feed. Matrimid is largely available as a commercial product. However, silica and CMS are not yet produced commercially. The price of inorganic membranes can be reduced in the future by optimizing the membrane production process on commercial scale which would make these membranes potentially even more suitable for He recovery process.

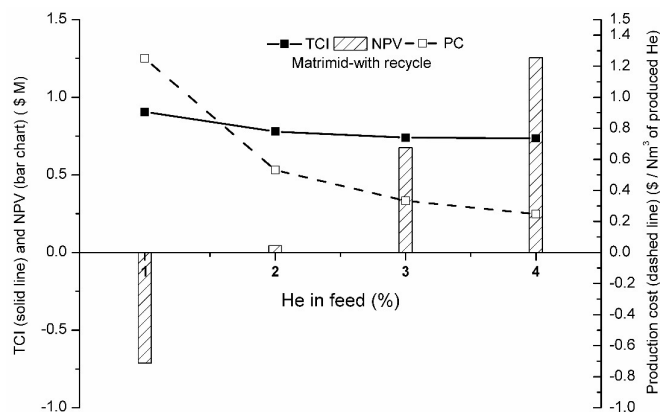

Fig. 18. TCI, PC, and NPV as function of He (%) in the feed when separating He from natural gas mixture with Matrimid; two-stage with recycle, P<sub>1</sub>: 70 bar, P<sub>2</sub>: 71 bar, T: 25°C.

Table 5

Summary of the results for He recovery from natural gas while using different membrane technologies

Membrane (Type)	Process (Two-stage)	He in feed (%)	TCI (\$M)	PC/Nm <sup>3</sup> of produced He (\$)	NPV (\$M)	Payback time (Years)
Silica	no recycle	5	0.28	0.07	2.5	1
CMS	no recycle	5	0.56	0.2	2.0	2.2
Matrimid	with recycle	4	0.74	0.25	1.3	3.6

## Acknowledgments

The authors would like to thank The Department of Chemical Engineering at NTNU for providing the possibility to work with this article.

## References

- [1] B.M. Adhikari, T. Truong, N. Bansal, B. Bhandari, Use of Gases in Dairy Manufacturing: A Review, Crit. Rev. Food. Sci. Nutr. 2017.1333488/1-13.
- [2] T. Yu, Y. Cheng, X. Wang, B. Tu, N. Cheng, J. Gong, L. Bai, Gases for establishing pneumoperitoneum during laparoscopic abdominal surgery, Cochrane. Db. Syst. Rev. 6 (2017) 1-87.
- [3] B.A. Glowacki, W.J. Nuttall, R.H. Clarke, Beyond the Helium Conundrum, IEEE Trans. Appl. Supercond. 23 (2013) 1-13.
- [4] W.J. Nuttall, R.H. Clarke, B.A. Glowacki, Resources: Stop squandering helium, Nature 485 (2012) 573-575.
- [5] A.J. Kidnay, W.R. Parrish, Trace Component Recovery or Removal, Fundamentals of Natural Gas Processing, CRC Press (2006) 209-221.
- [6] B.M. Oliver, J.G. Bradley, H. Farrar, Helium concentration in the Earth's lower atmosphere, Geochim. Cosmochim. AC 48 (1984) 1759-1767.
- [7] G. Sweeney, predicted rise in global energy demand, (2013) Accessed 23.05 2018. <http://www.zeroemissionsplatform.eu/extranet-library/publication/226-zepop-ed.html>.
- [8] L.M. Robeson, The upper bound revisited, J. Membr. Sci. 320(1-2) (2008) 390-400.
- [9] T.E. Rufford, K.I. Chan, S.H. Huang, E.F. May, A Review of Conventional and Emerging Process Technologies for the Recovery of Helium from Natural Gas, Adsorp. Sci. Technol. 32 (2014) 49-72.
- [10] J.P. Agrawal, S. Sourirajan, Helium separation by cellulose acetate membranes, J. Appl. Polym. Sci. 13 (1969) 1065-1068.
- [11] P.K. Gantzel, U. Merten, Gas Separations with High-Flux Cellulose Acetate Membranes, Ind. Eng. Chem. Pro. Design 9 (1970) 331-332.
- [12] J.S. Chiou, D.R. Paul, Gas permeation in a dry Nafion membrane, Ind. Eng. Chem. Res. 27 (1988) 2161-2164.
- [13] C.M. Zimmerman, W.J. Koros, Polypyrrolones for membrane gas separations. I. Structural comparison of gas transport and sorption properties, J. Polym. Sci. B Polym. Phys. 37(12) (1999) 1235-1249.
- [14] M. Kanezashi, T. Fujita, M. Asaeda, Nickel-Doped Silica Membranes for Separation of Helium from Organic Gas Mixtures, Sep. Sci. Technol. 40 (2005) 225-238.
- [15] F. Cao, C. Zhang, Y. Xiao, H. Huang, W. Zhang, D. Liu, C. Zhong, Q. Yang, Z. Yang, X. Lu, Helium Recovery by a Cu-BTC Metal-Organic-Framework Membrane, Ind. Eng. Chem. Res. 51 (2012) 11274-11278.
- [16] T.-H. Kim, W.J. Koros, G.R. Husk, Advanced Gas Separation Membrane Materials: Rigid Aromatic Polyimides, Sep. Sci. Technol. 23 (1988) 1611-1626.
- [17] C.A. Scholes, G.W. Stevens, S.E. Kentish, Membrane gas separation applications in natural gas processing, Fuel 96 (2012) 15-28.
- [18] C.A. Scholes, U.K. Ghosh, Review of Membranes for Helium Separation and purification. Membranes 7 (2017) 1-9.
- [19] A.H. Shelekhin, A.G. Dixon, Y.H. Ma, Adsorption, permeation, and diffusion of gases in microporous membranes. II. Permeation of gases in microporous glass membranes, J. Membr. Sci. 75 (1992) 233-244.
- [20] T.A. Centeno, A.B. Fuertes, Carbon molecular sieve gas separation membranes based on poly(vinylidene chloride-co-vinyl chloride), Carbon 38 (2000) 1067-1073.
- [21] S.S. Hosseini, T.S. Chung, Carbon membranes from blends of PBI and polyimides for N<sub>2</sub>/CH<sub>4</sub> and CO<sub>2</sub>/CH<sub>4</sub> separation and hydrogen purification, J. Membr. Sci. 328 (2009) 174-185.
- [22] E.P. Favvas, N.S. Heliopoulos, S.K. Papageorgiou, A.C. Mitropoulos, G.C. Kapanaidakis, N.K. Kanellopoulos, Helium and hydrogen selective carbon hollow fiber membranes: The effect of pyrolysis isothermal time, Sep. Purif. Technol. 142 (2015) 176-181.
- [23] J. Sunarso, S.S. Hashim, Y.S. Lin, S.M. Liu, Membranes for helium recovery: An overview on the context, materials and future directions, Sep. Purif. Technol. 176 (2017) 335-383.
- [24] C.A. Scholes, U. Ghosh, Helium separation through polymeric membranes: selectivity targets, J. Membr. Sci. 520 (2016) 221-230.
- [25] M. Ahsan, A. Hussain, Mathematical modelling of membrane gas separation using the finite difference method, Pacific Science Review A: Nat. Sci. Eng. 18 (2016) 47-52.
- [26] N.I. Laguntsov, I.M. Kurchatov, M.D. Karaseva, V.I. Solomakhin, P.A. Churkin, Influence of membrane selectivity on helium recovery from natural gas, Petrol. Chem. 56 (2016) 344-348.
- [27] S. Haider, A. Lindbräthen, J.A. Lie, I.C.T. Andersen, M.-B. Hägg, CO<sub>2</sub> separation with carbon membranes in high pressure and elevated temperature applications, Sep. Purif. Technol. 190(Supplement C) (2018) 177-189.
- [28] D. Grainger, PhD. Thesis (ISBN 978-82-471-4302-5), Development of carbon membranes for hydrogen recovery, NTNU, Trondheim, 2007.
- [29] P. Häussinger, R. Glatthaar, W. Rhode, H. Kick, C. Benkmann, J. Weber, H.-J. Wunschel, V. Stenke, E. Leicht, H. Stenger, Noble Gases, Ullmann's Encyclopedia of Industrial Chemistry, Wiley-VCH Verlag GmbH & Co, 2000.

- [30] J.A. Lie, PhD. Thesis: (ISBN 82-471-7191-0), Synthesis, performance and regeneration of carbon membranes for biogas upgrading – a future energy carrier, NTNU, Trondheim, 2005.
- [31] A. Soleimany, S.S. Hosseini, F. Gallucci, Recent progress in developments of membrane materials and modification techniques for high performance helium separation and recovery: A review, *Chem. Eng. Proc.* 122 (2017) 296-318.
- [32] M. Mulder, *Basic Principles of Membrane Technology*, Kluwer Academic Publishers, Netherlands, 1996.
- [33] S. Haider, A. Lindbråthen, J.A. Lie, P. Vattekar Carstensen, T. Johannessen, M.-B. Hägg, Vehicle fuel from biogas with carbon membranes; a comparison between simulation predictions and actual field demonstration, *Green Energ. Environ.* 3 (2018) 266-276.
- [34] S. Haider, A. Lindbråthen, M.-B. Hägg, Techno-economical evaluation of membrane-based biogas upgrading system: A comparison between polymeric membrane and carbon membrane technology, *Green Energ. Environ.* 1 (2016) 222-234.
- [35] T.C. Merkel, M. Zhou, R.W. Baker, Carbon dioxide capture with membranes at an IGCC power plant, *J. Membr. Sci.* 389 (2012) 441-450.
- [36] N.R. Council, *The impact of selling the federal helium reserve*, National Academy Press, Washington D.C., 2000.