



Research Paper

Effect of Complexation Reaction Constant on the Separation of Propylene/Propane by Supported Liquid Membrane

Maryam Takht Ravanchi¹, Tahereh Kaghazchi^{*1}, Ali Kargari²¹ Department of Chemical Engineering, Amirkabir University of Technology (Tehran Polytechnic), No. 424, Hafez Ave., P.O. Box 15875- 4413, Tehran, Iran² Membrane Processes Laboratory, Department of Petrochemical Engineering, Amirkabir University of Technology, Mahshahr Campus, Mahshahr, Iran

HIGHLIGHTS

- Determining equilibrium constant of the reaction between propylene and silver ion.
- Evaluating influence of pressure, temperature and silver concentration on equilibrium constant.
- Implementing volumetric method for determination of equilibrium constant value.

GRAPHICAL ABSTRACT

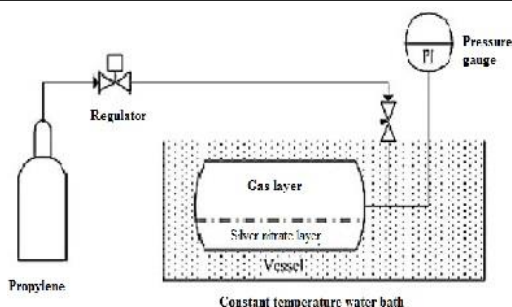

ARTICLE INFO

Article history:

Received 2014-08-08

Revised 2014-11-09

Accepted 2014-11-24

Available online 2014-11-25

Keywords:

Equilibrium constant
Supported liquid membrane
Propylene
Propane
Silver nitrate

ABSTRACT

Traditional systems for olefin/paraffin separation, like low-temperature distillation, are expensive and very energy consuming, and therefore, alternative separation methods are desired. Facilitated transport membranes are new tools for this separation to be substituted in large scale separation of olefin-paraffin mixtures. To design a membrane process for olefin-paraffin separation, equilibrium data is required. In the present work, silver nitrate (AgNO_3) was used as the carrier for facilitated transport of propylene. The equilibrium constant value of the reaction between propylene and silver ions was determined by the volumetric method. The influence of pressure, temperature and silver ion concentration on equilibrium constant value was evaluated.

© 2014 MPRL. All rights reserved.

1. Introduction

Currently, much attention is given to the separation of olefins and paraffins, one of the most important separation processes in the petrochemical industry. Facilitated transport membranes are new tools for this separation and nowadays many researchers studied their application for olefin-paraffin separation [1-7].

Facilitated transport is a process in which a transition metal binds reversibly and selectively with olefin at the feed side, transports the olefin through the membrane and releases it on the other side of the membrane.

The ability of the transition metal ion as a carrier is largely dependent on its electro-negativity and its salt's lattice energy. Based upon the criteria reported in the literature for these two parameters, silver salt is selected as a carrier for facilitated transport of olefin [8]. The most common generalized

* Corresponding author at: Fax: (+98)2166405847, Tel: (+98)2164543152
E-mail address: kaghazch@aut.ac.ir (T. Kaghazchi)

and overall reaction scheme for the transport of olefin across the membrane is [9]:



To design a membrane process for olefin-paraffin separation, equilibrium data of equation (1) is required. In case of ethylene-ethane separation, from 1950 to 1970, some articles were published about the equilibrium constant value of equation (1), the results of which are summarized in Table 1. In 1986, Teramoto and co-workers [10] reported the equilibrium constant value of ethylene-silver nitrate system as a function of silver nitrate concentration. In the case of propylene-propane separation, Chilukuri and co-workers [18] determined the equilibrium constant value of the complexation reaction between propylene and silver tetrafluoroborate (AgBF_4), the results of which are summarized in Table 2.

Table 1
Equilibrium constant value of the reaction between ethylene and silver ion at 298K.

Ag ⁺ concentration (mol/m ³)	Anion	Equilibrium constant value (m ³ /mol)	Reference
0-700	NO_3^-	0.116	11
1000	CF_3COO^-	0.094	12
50-100	NO_3^-	0.076 (at 303K)	13
0-9000	NO_3^-	0.119 (at 293K)	14
<100	NO_3^-	0.086 (at 303K)	15
500-1000	NO_3^-	0.098	16
<100	NO_3^-	0.085	17

Table 2
Equilibrium constant value of the reaction between propylene and silver ion at 293K [18].

Solution	(mol of C_3H_6)/(mol of AgBF_4)	Equilibrium constant value (m ³ /mol)
3.0 M AgBF_4	0.45	0.2
5.5 M AgBF_4	0.75	1.1
7.5 M AgBF_4	0.98	26.1

In the present work, silver nitrate (AgNO_3) was used as the carrier for facilitated transport of propylene and the equilibrium constant value of the reaction between propylene and silver nitrate was determined as a function of pressure, temperature and carrier concentration. On the other hand, the performance of a facilitated transport membrane system for the separation of a propylene-propane mixture was investigated.

2. Experimental Section

2.1. Equilibrium Constant Evaluation

Determination of Equilibrium Constant: The equilibrium constant of the complexation reaction between propylene and silver ion (Ag^+) was determined by the volumetric method [10].

Materials: Industrial grade propylene from Tabriz Petrochemical Company with 99.74 mol% purity was used as feed gas. Silver Nitrate (AgNO_3 , GR Pro Analysis) which was purchased from Merck Co. was used as carrier salt. An aqueous solution of silver nitrate was prepared by dissolving silver nitrate in deionized water. All chemicals were used without further purification.

Apparatus and Procedure: A schematic diagram of the apparatus used is presented in Figure 1. A predetermined volume of an aqueous solution of AgNO_3 with predefined concentration was added to a closed end stainless steel vessel with a volume of 1060 cm³. After immersing the vessel in water bath (Memmert, WNB 14), pure propylene was introduced to the vessel until a desired pressure was reached. Then the vessel was disconnected from the cylinder and shaking the vessel was started and continued until no more pressure drop was observed. During all experiments, the vessel was immersed in the water bath to maintain its temperature at a constant value. The pressure was measured by a test pressure gauge (Badotherm, Holland, AISI 316).

Determination of Equilibrium Constant: The reaction between propylene and silver cation (Ag^+) is expressed as below [2, 9]:



The equilibrium constant of this reaction is defined as [19]:

$$K = \Pi(\hat{a}_i)^{\nu_i} \quad (3)$$

where,

$$\hat{a}_i = \frac{\hat{f}_i}{f_i^0} \quad (4)$$

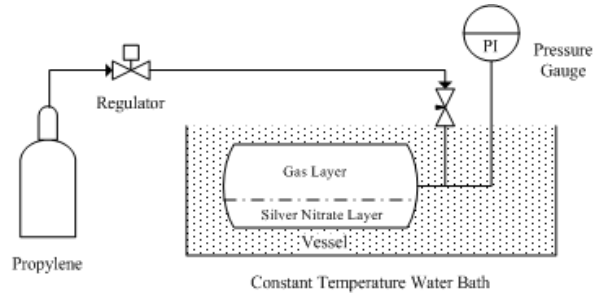

Fig. 1. Schematic diagram of the apparatus used for determination of equilibrium constant

For the gas phase, $f_i^0 = 100\text{kPa}$. Therefore,

$$\hat{a}_i^g = \frac{\hat{f}_i^g}{f_i^0} = \frac{\hat{\Phi}_i P_i}{100} \quad (5)$$

For the liquid phase:

$$\hat{a}_i^l = \frac{\hat{f}_i^l}{f_i^0} = \frac{\gamma_i f_i x_i}{f_i^0} = \gamma_i x_i \frac{f_i}{f_i^0} \quad (6)$$

Since the fugacities of liquids are weak functions of pressure, the ratio is often taken as unity. Thus,

$$\hat{a}_i^l = \gamma_i x_i \quad (7)$$

Liquid phase and gas phase were assumed to be ideal. Hence,

$$\hat{\Phi}_i = 1 \quad (8)$$

$$\gamma_i = 1 \quad (9)$$

Substituting equation (8) in equation (5) and equation (9) in equation (7), a simplified relationship was obtained for the activity:

$$\hat{a}_i^g = \frac{P_i}{100} \quad (10)$$

$$\hat{a}_i^l = x_i \quad (11)$$

Expanding equation (3) according to equation (2) and substituting equations (10) and (11) for activities, a correlation for equilibrium constant was obtained as below:

$$K = \frac{\hat{a}_c^l}{\hat{a}_a^g \hat{a}_b^l} = \frac{100x_c}{P_a x_b} \quad (12)$$

where

$$P_a = \frac{n_a RT}{V} \quad (13)$$

$$x_b = \frac{n_b}{n_b + n_c}$$

$$x_c = \frac{n_c}{n_b + n_c}$$

Thus,

$$K = \frac{n_c}{n_a n_b} \frac{100V}{RT} \quad (14)$$

In the beginning of the reaction, n_0 mole of propylene and n_{Ag} mole of silver ion were presented in the reaction mixture. After completion of the reaction, n_1 mole of propylene was left in the reaction mixture. Thus,

$$n_a = n_1 \quad (15)$$

$$n_b = n_{Ag} - n_c$$

$$n_c = n_0 - n_1$$

In order to calculate the values of n_a , n_b and n_c , the Peng-Robinson (PR) equation of state was used:

$$P = \frac{RT}{\bar{V} - b} - \frac{a}{\bar{V}(\bar{V} + b) + b(\bar{V} - b)} \quad (16)$$

where

$$a(T, \omega) = 0.45724(R^2 T_c^2 / P_c) \alpha(T, \omega) \quad (17)$$

$$\alpha^{0.5} = 1 + (1 - T_r^{0.5})(0.37464 + 1.5422\omega - 0.26992\omega^2)$$

$$b = 0.07780 RT_c / P_c$$

At initial pressure (P_0) and final pressure (P_1), equation (16) was solved to calculate molar volumes (\bar{V}_0 and \bar{V}_1). On the other hand, the volume of cylinder and the volume of $AgNO_3$ solution were known. Therefore,

$$\text{Propylene volume (V)} = \text{cylinder volume} - \text{AgNO}_3 \text{ solution volume} \quad (18)$$

Moreover n_0 and n_1 were calculated as below:

$$\bar{V}_0 = \frac{V}{n_0} \Rightarrow n_0 = \frac{V}{\bar{V}_0} \quad (19)$$

$$\bar{V}_1 = \frac{V}{n_1} \Rightarrow n_1 = \frac{V}{\bar{V}_1}$$

Substituting equations (19) and (15) in equation (14), the equilibrium constant value was obtained.

2. 2. Facilitated Transport Separation

Materials: Industrial grade propylene (99.74 mol.%) from Tabriz Petrochemical Company and industrial grade propane (99.79 mol.%) from Tehran Refinery Complex were used as feed gases and pure nitrogen was used as sweep gas. Silver Nitrate ($AgNO_3$, GR Pro Analysis) which was purchased from Merck Co. was used as the carrier of propylene. An aqueous solution of silver nitrate was prepared by dissolving silver nitrate in deionized water. Hydrophilic polyvinylidene difluoride (PVDF) flat sheet membranes (Durapore from Millipore, thickness 125 μm , pore size 0.22 μm , filter diameter 142 mm) were used as the support of the liquid membrane. After being immersed in the carrier solution, the membrane filter was sandwiched between two compartments of the module. Once prepared, the membrane filter could be used for 3–4 weeks with no change in separation and permeation properties.

Apparatus and Procedure: The schematic diagram of the experimental setup is shown in Figure 2. All tubing used to connect all parts of the setup was stainless steel (AISI 316). The experimental procedure is as follows. Propylene and propane, after passing through mass flow controllers (Brooks Instruments, model 5850S), were mixed and entered the humidifier. The humidified feed passed through a temperature control system and entered the membrane cell. A combination of a heater and a cooler were used as the temperature control system. The feed gas was introduced to the upper compartment of the cell and the sweep gas, nitrogen, was supplied to the lower compartment. The main product, permeate, was collected from the lower compartment and the secondary product, retentate was collected from the upper compartment. A back pressure regulator (BPR, Tescom, Germany) was used on the retentate line to control the pressure of the system. During all experiments, sweep gas was at atmospheric pressure. The experiments were conducted at room temperature (298K). All the experimental data were obtained after an initial permeation period of 4–6 hr. The gas composition was determined by a Gas Chromatograph (Agilent 6890N) equipped with a Flame Ionization Detector (FID, Agilent Technologies Inc. column, HP Al-S, 0.53mm in diameter, and 50m in length). Furthermore, separation factor is defined as:

$$\alpha_{AB} = \frac{y_A^p / y_B^p}{y_A^f / y_B^f} \quad (20)$$

3. Results and Discussion

3.1. Equilibrium Constant Evaluation

In evaluating the value of equilibrium constant, the influence of different parameters such as pressure, temperature and concentration of $AgNO_3$ were considered. These operating parameters were selected at values that would have application in a real process. The results were presented in Table 3.

The effect of pressure on equilibrium constant values with Ag^+ concentration as a variable at different temperatures is shown in Figures 3-5. As it is obvious in these figures, at constant temperature and pressure, the equilibrium constant value and the Ag^+ concentration are inversely proportional. Figures 6-8 depict the influence of temperature on equilibrium constant value at different Ag^+ concentrations. At constant Ag^+ concentration and pressure, the less the temperature, the more the equilibrium constant value. When a lower concentration of Ag^+ was used, temperature had more influence on equilibrium constant value. At constant temperature and Ag^+ concentration, the equilibrium constant value was increased by increasing the pressure.

Table 3
Equilibrium constant (K) of the reaction between propylene and silver ion.

T (°C)	Ag ⁺ solution (wt.%)					
	5% Ag ⁺		10% Ag ⁺		20% Ag ⁺	
	P (kPa)	K (kPa ⁻¹)	P (kPa)	K (kPa ⁻¹)	P (kPa)	K (kPa ⁻¹)
21	86	1.610	69	0.930	65	0.441
	169	2.030	179	1.280	139	0.654
	255	2.360	252	1.440	224	0.855
	338	2.600	334	1.600	317	0.985
25	86	1.025	79	0.517	72	0.272
	183	1.490	134	0.675	148	0.484
	272	1.831	258	1.009	231	0.677
	348	2.010	341	1.192	321	0.823
40	93	0.480	90	0.240	90	0.061
	183	0.635	200	0.455	169	0.203
	276	0.827	258	0.560	252	0.316
	372	1.056	355	0.770	341	0.438

The absorption of propylene in silver salt solution is a chemical absorption for which higher pressure and lower temperature is favorable. The results of Table 3 prove this concept, i.e. at constant Ag^+ concentration and constant temperature, equilibrium constant value and pressure are directly proportional. On the other hand, at constant Ag^+ concentration and constant pressure, equilibrium constant value and temperature are inversely proportional.

The equilibrium constant value depends on silver ion concentration which itself depends on the degree of dissociation of silver salt in the solution. Nimeijer and co-workers [20] reported that an increase in $AgNO_3$ concentration resulted in a decrease in the degree of dissociation and this consequently decreased the equilibrium constant value. As it is obvious in Table 3, at constant pressure and constant temperature, equilibrium constant value and Ag^+ concentration are diversely proportional.

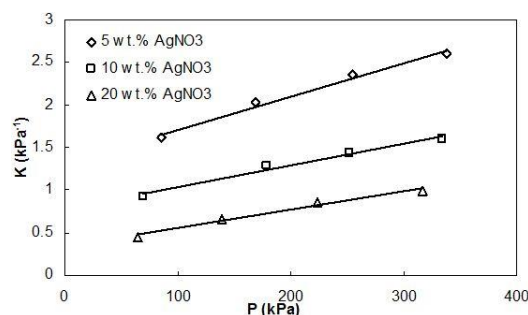

Fig. 3. The effect of pressure on equilibrium constant value with Ag^+ concentration as variable at 21 °C.

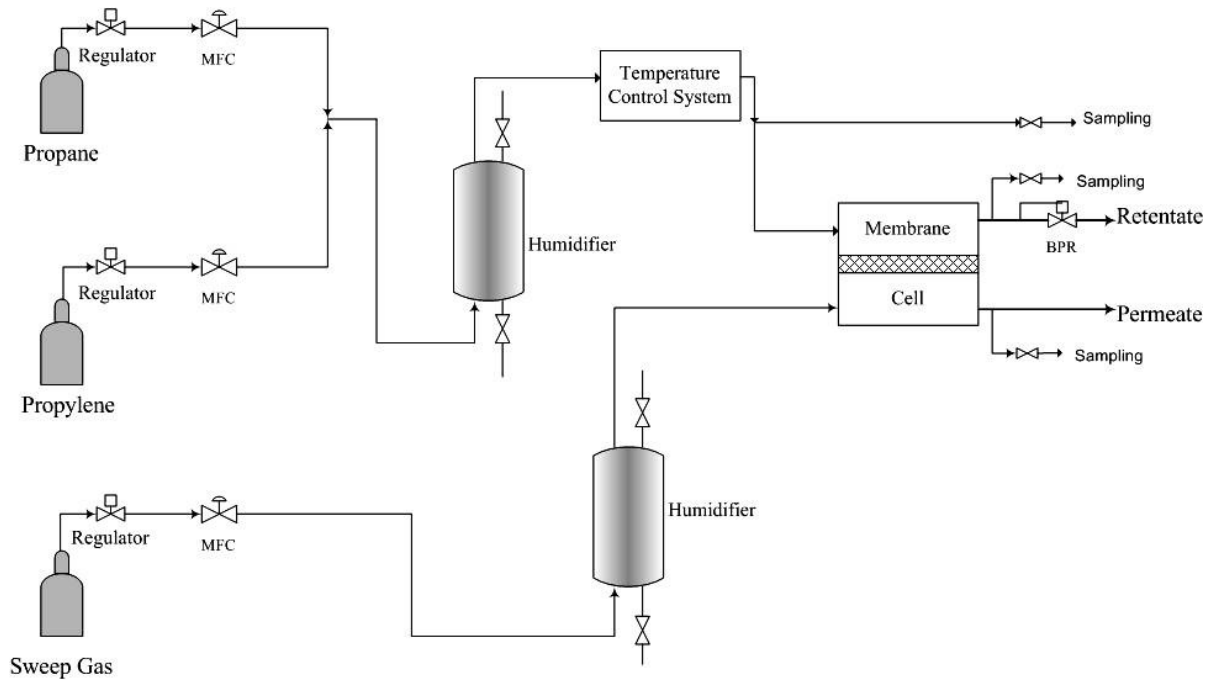

Fig. 2. Schematic diagram of the experimental membrane separation setup.

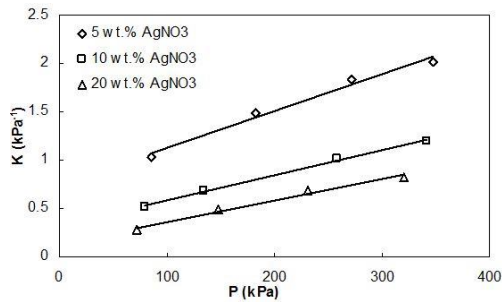

Fig. 4. The effect of pressure on equilibrium constant value with Ag^+ concentration as variable at 25 °C.

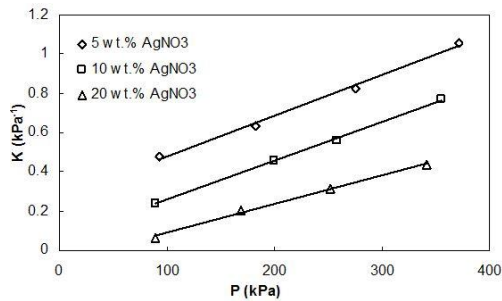

Fig. 5. The effect of pressure on equilibrium constant value with Ag^+ concentration as variable at 40 °C.

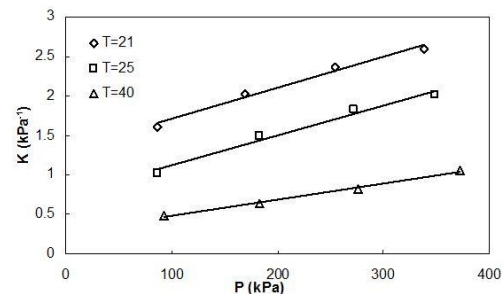

Fig. 6. The effect of pressure on equilibrium constant value with temperature as variable for 5 wt.% AgNO_3 solution.

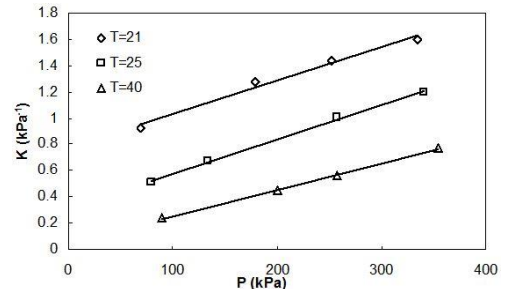

Fig. 7. The effect of pressure on equilibrium constant value with temperature as variable for 10 wt.% AgNO_3 solution.

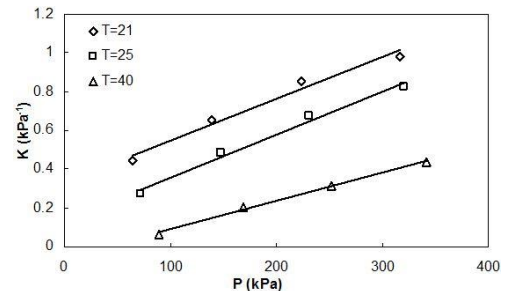

Fig. 8. The effect of pressure on equilibrium constant value with temperature as variable for 20 wt.% AgNO_3 solution.

3.2. Facilitated Transport Separation

The effect of operating parameters of a membrane separation process such as trans-membrane pressure, carrier concentration and feed composition on separation factor were evaluated and tabulated in Table 4. As it can be seen, trans-membrane pressure and separation factor are directly proportional and increasing the trans-membrane pressure will cause an increase in the separation factor and a more purified product will be obtained.

Facilitated transport is a combination of two processes: absorption (on the feed side) and stripping (on the permeate side). Increasing the pressure is in favor of absorption and decreasing the pressure is in favor of stripping. Thus, increasing the feed pressure increases the absorbed propylene on the feed side. Due to the pressure difference between the feed side and the permeate side, the complexed propylene is decomplexed on the permeate

side. Therefore, the more the transmembrane pressure, the more the driving force for separation. Based on this fact, more propylene was transported

across the membrane and separation factor and propylene permeability was increased.

Table 4

The effect of operating parameters of a membrane separation process on separation factor.

Propylene:propane mixture (vol.%)	Ag ⁺ concentration (wt.%)					
	5% Ag ⁺		10% Ag ⁺		20% Ag ⁺	
	Trans-membrane pressure (kPa)	Separation factor	Trans-membrane pressure (kPa)	Separation factor	Trans-membrane pressure (kPa)	Separation factor
30:70	50	49.87	50	63.03	50	268.98
	70	60.56	70	90.26	70	356.64
	100	80.41	100	137.39	100	437.92
	120	86.73	120	163.15	120	473.86
50:50	50	44.45	50	59.97	50	187.68
	70	55.5	70	82.33	70	221.22
	100	64.79	100	111.36	100	249
	120	70.43	120	13.58	120	269.27
70:30	50	33.32	50	48.27	50	115.4
	70	47.72	70	69.83	70	129.44
	100	57.49	100	96.97	100	142.43
	120	65.5	120	109.46	120	152.63

4. Conclusion

The equilibrium constant value of the reaction between propylene and silver ion was determined by the volumetric method and the influence of pressure, temperature and carrier concentration on equilibrium constant value was investigated. It was observed that increasing the pressure, decreasing the temperature and decreasing the carrier concentration is in favor of equilibrium constant value. From the viewpoint of separation, a facilitated transport membrane can separate a C₃ mixture with success and increasing trans-membrane pressure is in favor of the separation factor.

Nomenclature

\hat{a}_i	activity of component <i>i</i>
\hat{f}_i	fugacity of component <i>i</i>
f_i^0	fugacity of component <i>i</i> at temperature of the system and pressure 100kPa
<i>K</i>	equilibrium constant (kPa ⁻¹)
<i>n_i</i>	mole of the component <i>i</i> (mole)
<i>P</i>	pressure (kPa)
<i>P_c</i>	critical pressure (kPa)
<i>P_i</i>	pressure of component <i>i</i>
<i>R</i>	universal gas constant
<i>T</i>	temperature
<i>T_c</i>	critical temperature (K)
<i>T_r</i>	reduced temperature, dimensionless
<i>v_i</i>	stoichiometric coefficient
\bar{V}	molar volume of propylene (cm ³ /mole)
<i>V</i>	propylene volume, (cm ³)
<i>w</i>	eccentric factor
<i>x_i</i>	mole fraction of component <i>i</i> in liquid phase
<i>y_j</i>	mole fraction of component <i>i</i> in the <i>j</i> stream

Greek symbols

ϕ_i	fugacity coefficient of component <i>i</i> in solution
γ_i	activity coefficient of component <i>i</i>

Subscript

<i>a</i>	permeant species (propylene)
<i>A</i>	Propylene
<i>b</i>	carrier (Ag ⁺)
<i>B</i>	Propane
<i>c</i>	carrier- solute complex
<i>0</i>	initial value
<i>l</i>	final value
Ag ⁺	silver ion

Superscript

<i>f</i>	feed stream
<i>l</i>	liquid phase
<i>g</i>	gas phase
<i>P</i>	permeate stream

Acknowledgement

The authors gratefully acknowledge the financial support received in the form of a research grant (research project No.: 83111149) from the National Petrochemical Company- Research and Technology center (NPC-RT), Iran.

Reference

- [1] M. Takht Ravanchi, T. Kaghazchi, A. Kargari, Application of Membrane Separation Processes in Petrochemical Industry: A Review, *Desalination*. 235 (2009) 199-244.
- [2] J.D. Way, R.D. Noble, Facilitated transport, in: W.S. Ho, S.S. Sirkar, (Eds.), *Membrane Handbook*, Van Nostrand, New York, 1992.
- [3] Y.S. Kang, J.H. Kim, J. Won, H.S. Kim, Solid-State Facilitated Membranes for Separation of Olefins/Paraffins and Oxygen/Nitrogen, in: Y. Yampolskii, I. Pinnau, B. Freeman, (Eds.), *Materials Science of Membranes for Gas and Vapor Separation*, John Wiley & Sons, England, 2006.
- [4] R.W. Baker, *Membrane Technology and Applications*, 2nd Ed., John Wiley & Sons, England, 2004.
- [5] R.L. Burns, W.J. Koros, Defining the challenges for C₃H₆/C₃H₈ separation using polymeric membranes. *J. Membr. Sci.*, 211 (2003) 299-309.
- [6] Y. Yoon, J. Won, Y.S. Kang, Polymer electrolyte membranes containing silver ion for facilitated olefin transport. *Macromolecules* 33 (2000) 3185-3186.
- [7] J.H. Kim, S.M. Park, J. Won, Y.S. Kang, Unusual separation property of propylene/propane mixtures through polymer/silver complex membranes containing mixed salts. *J. Membr. Sci.* 248 (2005) 171-176.
- [8] Y.S. Kang, H.C. Park, J.O. Won, S.U. Hong, T.M. Kwon, Facilitated Transport Separation Membranes using Solid State Polymer Electrolytes. U.S. Patent 2001/0015334, August 23, 2001.
- [9] R.D. Noble, C.A. Koval, Review of Facilitated Transport Membranes, in *Materials Science of Membranes for Gas and Vapor Separation*, Y. Yampolskii, I. Pinnau, B. Freeman (Eds.), John Wiley and Sons Ltd., 2006.
- [10] M. Teramoto, H. Matsuyama, T. Yamashiro, Y. Katayama, Separation of ethylene from ethane by supported liquid membranes containing silver nitrate as a carrier, *J. Chem. Eng. Jpn.*, 19 (1986) 419-424.
- [11] B.B. Baker, The effect of metal fluoroborates on the absorption of ethylene by silver ion. *Inorg. Chem.* 3 (1964) 200-202.
- [12] P. Brandt, Addition compounds of olefins with metal salts, II. The reaction of ethylene with silver ions in aqueous solutions. *Acta Chem. Scand.* 13 (1959) 1639-1652.
- [13] H.L. Clever, Solubility of ethylene in aqueous silver nitrate and potassium nitrate solutions. *J. Chem. Eng. Data.* 15 (1970) 411-413.
- [14] J.V. Crookes, A.A. Woolf, Competitive interactions in the complexing of ethylene with silver (I) salt solutions. *J. Chem. Soc., Dalton Trans.* 1973, 12, 1241-1247.
- [15] O.N. Temkin, A.G. Ginzburg, R.M. Flid, Soluble complexes of unsaturated hydrocarbons with metal salts and their effect on catalytic reactions. *Kinet. Catal.* 5 (1964) 195.
- [16] K.N. Trueblood, H.J. Lucas, Coordination of silver ion with unsaturated compounds. V. Ethylene and propene. *J. Am. Chem. Soc.* 74 (1952) 1338-1339.
- [17] S.P. Wasik, W. Tsang, Gas chromatographic determination of partition coefficients of some unsaturated hydrocarbons and their deuterated isomers in aqueous silver nitrate solutions. *J. Phys. Chem.* 1970, 74 (15), 2970-2976.
- [18] P. Chilukuri, K. Rademakers, K. Nymeyer, L. Ham, H. Berg, Propylene/Propane Separation with a Gas/Liquid Membrane Contactor Using a Silver Salt Solution, *Ind. Eng. Chem. Res.* 46 (2007) 8701-8709.
- [19] J.M. Smith, H.C. Van Ness, *Introduction to Chemical Engineering Thermodynamics*, McGraw-Hill, New York, 4th Ed., 1986.
- [20] K. Nymeyer, T. Visser, W. Brillman, M. Wessling, Analysis of the complexation reaction between Ag⁺ and ethylene, *Ind. Eng. Chem. Res.*, 43 (2004) 2627-2635.