



Research Paper

Physical Backwash Optimization in Membrane Filtration Processes: Seawater Ultrafiltration Case

Fatma Zohra Slimane ^{1,2,*}, Fatma Ellouze ^{1,2}, Ghofrane Ben Miled ³, Nihel Ben Amar ^{1,2}¹ Université de Carthage, Institut National des Sciences Appliquées et de Technologie, B.P.676, 1080 Tunis Cedex, Tunisie² Université de Tunis El Manar, Ecole Nationale d'Ingénieurs de Tunis, LR99ES20 Modélisation Mathématique et Numérique dans les Sciences de l'Ingénieur, LAMSIN, B.P. 37, 1002 Tunis, Tunisie³ Université de Tunis El Manar, Institut Supérieur des Sciences Biologiques Appliquées de Tunis, 9, rue docteur Zouheir Safi, Tunis, Tunisie

Article info

Received 2017-06-20

Revised 2017-09-05

Accepted 2017-09-06

Available online 2017-09-06

Keywords

Ultrafiltration (UF)

Backwash

Optimization

Response surface methodology (RSM)

Water treatment

Highlights

- RSM was used to optimize physical backwash in seawater ultrafiltration.
- Effects of backwash interval BWI, duration BWD, and flow BWF were studied by RSM.
- Optimization aims to maximize net water production and minimize fouling.
- 30 and 60 min filtration cycle insures a maximal net water production.
- Optimal parameters are: 30 min BWI, [15-30 s] BWD and [10-20 L.min⁻¹] BWF.

Abstract

Seawater ultrafiltration (UF) as a pretreatment of reverse osmosis (RO) process in a thermal power plant was investigated using a 100 kDa hollow fiber membrane. The choice of the UF physical backwash conditions remains arbitrary or ensuing from a sensibility study. As the optimum must take into account the factors interactions, we led a response surface study to analyze the effect of backwash interval BWI (30–90 min), backwash flow-rate BWF (10–34 L.min⁻¹) and backwash duration BWD (15–45 s) on two responses: the Specific Flux Reduction (SFR) and the Net Water Production (NWP). Polynomial models describing the responses sensitivity with respect to the three variables were established to determine the optimal conditions corresponding to maximal NWP while assuring lowest fouling. Results showed that fouling is mainly controlled by BWI. For the NWP, all the variables are significant especially their quadratic and interaction terms. Maximal NWP and low SFR can be reached at 30 min BWI, for a BWD and BWF ranges of [15-30 s] and [10-21 L.min⁻¹], respectively.

Graphical abstract

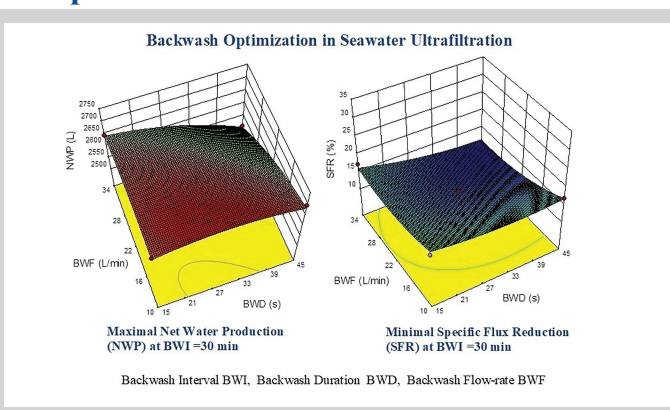

© 2018 MPRL. All rights reserved.

1. Introduction

Ultrafiltration (UF) is becoming more widely used for the Reverse Osmosis (RO) pretreatment. It is effective for removing suspended solids, colloidal material, scales and microorganisms assuring in the same time high permeate flux and low pressure requirement. Despite of its numerous advantages, UF must be applied with precaution and in the optimized conditions to minimize clogging. As a preventive measure against membrane fouling, physical cleaning (e.g. backwashing, relaxation,

flushing, etc.) is usually introduced into UF operation to remove foulants from the membrane surface or pores. The idea of this work is to optimize the physical cleaning procedure in order to maximize net water production and minimize fouling to have less frequent recourse to chemical cleaning.

Several research works have focused on the study of membrane cleaning to control clogging and to minimize its impact during filtration. Studies reported in the literature about the optimization of the cleaning procedure are

* Corresponding author at: Phone: +216 21780283; fax: +216 71233861
E-mail address: imanslimane@gmail.com (F.Z. Slimane)

varied and depend on the target applications. We will limit the bibliography to water applications and particularly seawater UF (our case of study).

Several authors [1-9] demonstrated, by a sensitive study, the importance of controlling the backwash operating parameters, such as BWI and BWD. All those authors have agreed that prolonged filtration duration would decrease the product water due to a more pronounced irreversible fouling [1-6]. On the other hand, short BWI (~20 min) can lead to frequent backwash which decreases the net water production [1, 3]. Moreover, increasing backwash duration can lead to higher product flow (i.e., less fouling) but higher water consumption [3, 4, 7]. According to Ye et al. [4], BWD had positive effect on clogging but beyond 30 s no obvious improvement observed. Other parameters such as backwash pressure, backwash flow and backwash strength (i.e., ratio between backwash and filtration flux) have also been discussed [2-4, 7]. For example, Xu et al. [3] investigated the effect of backwash flow during seawater UF and showed that BWF did not affect the fouling reduction, significantly. Ye et al. [4] discussed the effect of backwash strength during seawater UF. They demonstrated that the percentage of fouling removed by backwash increased from 77.6% to 85.2% with the increase of backwash strength from 0.5 to 1.5 times of filtration flux. However, a backwash flux higher than 1.5 times the filtration flux is unable to minimize fouling. But it resulted in a higher fouling rate during filtration because the backwash solution impurities can at high velocities clog the residual fouling cake.

The above mentioned sensibility studies have confirmed the importance of the backwash operating parameters. But this can be claimed that these works did not sufficiently investigate the interaction among the proposed operating parameters. The experimental design methodology and specifically the response surface methodology (RSM) based on multi-parameters optimization are a useful tool to evaluate all the parameters combinations and their interaction effects.

RSM studies have been widely used in many fields for membrane process design [10-17], but few researches have been done in the field of physical cleaning optimization [17-19]. For surface water ultrafiltration, Guerra et al. [17] used the response surface methodology to find the optimum of Reynolds number (Re), TMP, coagulant dose, BWI and BWD (backwashing every 5 min for 60 s, backwashing every 15 min for 60 s, no backwash). They found that the optimal backwash strategy for minimizing the flux decline and maximizing the average flux are backwashing every 5 min for 60 s. Chen et al. [18] also for municipal waste water UF clearly proved, by response surface, that the physical cleaning under optimized procedure enhances the permeate flux with an increase of 11% of the clean water recovery and a decrease of the wash water usage of 16%.

For seawater UF application, there is always a lack of the backwash procedure optimization. In fact, to date, the recommended procedures are, at best, based on a sensitive or screening study [20] and not on a response surface methodology. The idea of this work is to apply RSM for the optimization of the physical cleaning strategy for the seawater UF as pretreatment of a reverse osmosis unit in the thermal plant (STEG, Tunisia). The effect of Backwash Interval (BWI), Backwash flow (BWF) and Backwash duration (BWD) were studied on the Specific Flux Reduction and the Net Water Production. The ultimate goal of this work is to develop an optimized physical cleaning strategy for seawater ultrafiltration assuring a

good compromise between fouling reduction and permeate water consumption.

2. Material and methods

2.1. Feed water

The seawater was taken from the thermal plant pumping station after physical and chemical treatments. The physical treatment consists on successive filtration steps through a grid for the elimination of great size bodies (10 cm), a grid scraper for the retention of smaller particles (3 cm), a rotary grid (mesh size 4 mm) and finally a debris filter (mesh size 2 mm). Then, it undergoes 1 ppm continuous chlorination and 2 ppm shock chlorination for 15 min, each 8 hours, respectively. At the end of the pretreatment chain, the seawater has the characteristics shown in Table 1.

2.2. Pilot system

For the purpose of this study, a pilot system was designed and realized as is shown in Figure 1. The pilot is equipped with a hollow fiber cross flow ultrafiltration membrane (Polymem UF30M2). The membrane proprieties are mentioned in Table 2.

During filtration, seawater is fed from the feed tank (FT) by a feed pump (P1). It passes a 50 μm cartridge filter (CF) and the flow-meter FM1. The feed, retentate and permeate pressures are measured by the M2, M3, and M4 manometers, respectively. The retentate is recycled to the feed tank and the permeate volume is measured by the water meter WM1 then collected in the backwash tank BT.

During backwash steps, permeate is pumped from the backwash tank by P2 pump and enter the UF module in out/in configuration. The backwash flow and pressure are measured by the flow meter FM3 and the manometer M5, respectively. The water meter WM2 measures the volume of the consumed water during backwash. The water used for backwash is discharged.

The difference between the produced water (permeate) indicated by WM1 and consumed water (for the backwash) measured by WM2, is the Net Water Production (NWP).

2.3. The experimental approach

A preliminary study was conducted to select the appropriate experimental conditions corresponding to the maximal conversion rate ($Y=Q_p/Q_o$) and the minimal permeate turbidity. Figure 2 shows the evolution of the conversion rate, the feed and the permeate turbidities versus relative feed pressure. We note that the permeate turbidity remained constant (i.e., 0.2 NTU) which confirms the well choice of the membrane MWCO (100 KDa). It is worth quoting that the turbidity met the requirement standard of the RO membrane feed (i.e., less than 0.5 or 1 NTU according to the constraint of the RO membrane producer). Therefore, it is not useful to operate with lower molecular weight cut off as it could induce a more expensive backwashing step.

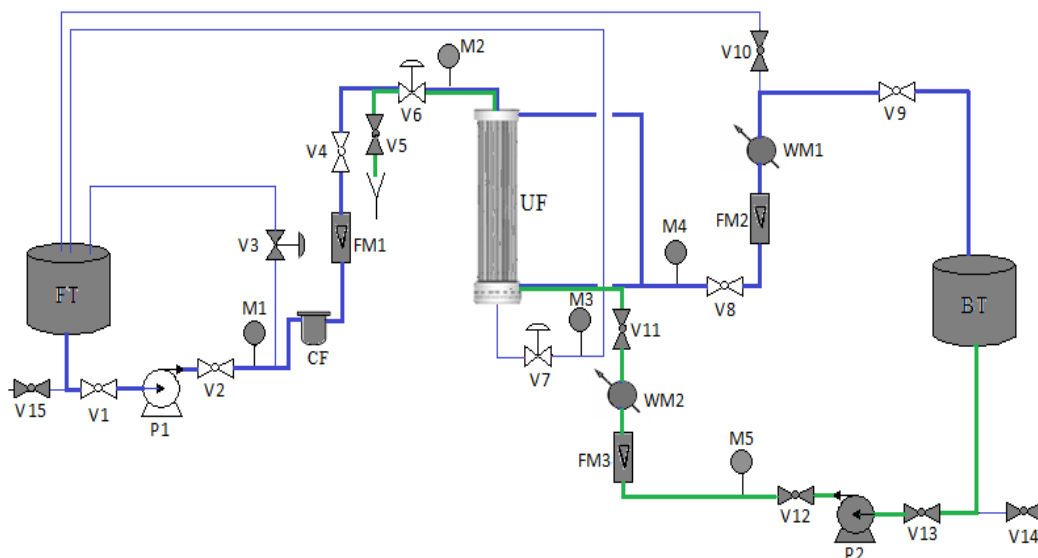

Fig. 1. A general scheme of UF experimental set-up.

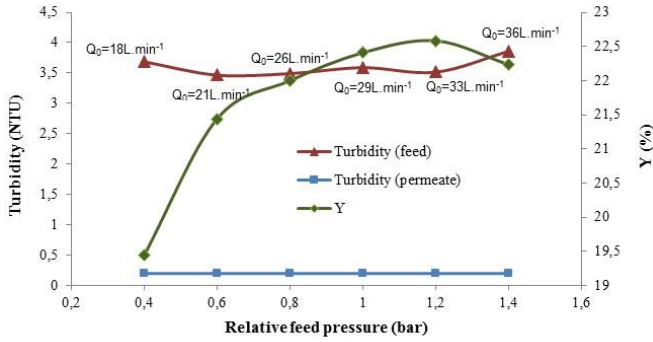

Fig. 2. Conversion rate Y and turbidity versus feed pressure. (Q₀: feed flow).

Table 1
Feed water characteristics.

Property	Value
pH	8.3
Turbidity* (NTU)	4.4
Total hardness (°F)	640
Conductivity** (mS)	53.5

*Turbidity is measured by HACH2100P turbidimeter.
**Conductivity is measured by WTW conductimeter with the 325WTW LF597 electrode.

Table 2
Membrane specifications.

Membrane UF30M2 (polymem)	
Membrane material	Polysulfone
Membrane configuration	In/Out
Molecular weight cut off (kDa)	100
Area (m ²)	4.2
Module length (mm)	1.100
Module diameter (mm)	90
Fiber external diameter (mm)	0.85
Pure water permeability (L/h.m ² .bar)	565.5

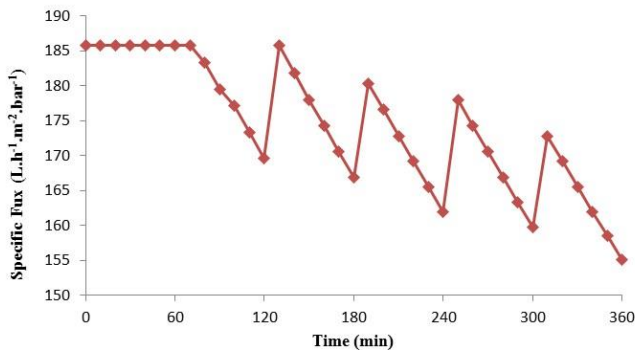

Fig. 3. The specific flux variation versus time. BWI = 60 min, BWD = 30s, BWF = 22 L.min⁻¹.

The highest conversion rate (Y) is observed at a feed pressure ranging between 1 and 1.2 bar. As the quality of permeate and the maximal conversion rate are assured in this range, a feed pressure of 1.1 bar corresponding to a feed flow 30 L.min⁻¹ was chosen for the further experiments.

All experiments consist on a successive filtration–backwash phases carried out during 360 min (6 hours) by applying backwash at regular intervals. Figure 3 shows an example of the evolution of Specific Flux (SF, Eq. 1) for an experiment carried out at 60 min filtration cycle.

$$SF = \frac{J}{TMP} \quad (1)$$

J and TMP are the permeate volumetric flux and the transmembrane pressure, respectively.

Table 3
The factors and their levels.

Variable	Factor	Unit	Levels
X1	Backwash Interval	BWI	min 30, 60, 90
X2	Backwash Duration	BWD	s 15, 30, 45
X3	Backwash Flow-rate	BWF	L.min ⁻¹ 10, 22, 34

2.4. Experimental design

A surface response methodology was adopted to establish a relation between the studied responses (e.g. the Specific Flux Reduction, SFR defined in Eq.2 and the Net Water Production, defined in section 2.2) and three selected experimental parameters (e.g. backwash interval BWI, backwash duration BWD and backwash flow-rate BWF). Those parameters were selected on the basis of a screening study which demonstrated their significant effect on NWP. Each factor has three levels which are summarized in Table 3.

$$SFR (\%) = \frac{SF_0 - SF_f}{SF_0} * 100 \quad (2)$$

Indices 0 and f correspond to the beginning and the end of the operating experiments duration, respectively.

For predicting the optimal conditions ensuring the minimum of fouling with the maximum of water production, a second-order polynomial function was fitted to correlate the relationship between variables and responses. This function can be written as follows:

$$y = b_0 + b_1X_1 + b_2X_2 + b_3X_3 + b_{1-1}X_1^2 + b_{2-2}X_2^2 + b_{3-3}X_3^2 + b_{1-2}X_1X_2 + b_{1-3}X_1X_3 + b_{2-3}X_2X_3 \quad (3)$$

where y is the predicted response, the factors X₁, X₂ and X₃ are backwash interval, backwash duration and backwash flow, respectively. b₀ is a constant coefficient;

b₁, b₂ and b₃ are the coefficients corresponding to the relative effects of the linear variables X₁, X₂, and X₃, respectively; b₁₋₁, b₂₋₂, b₃₋₃ are respectively the coefficients corresponding to the relative effects of the quadratic variables of X₁, X₂, or X₃ on the response;

b₁₋₂, b₁₋₃, b₂₋₃ are respectively the coefficients corresponding to the relative effects of the interactions between two variables X₁-X₂, X₁-X₃, and X₂, X₃ on the response.

Central composite design, consisting of 24 experiments (see Table 4), was generated using experimental design software (Nemrodw version 2007_3). The experimental data of the design were fitted with polynomial model in order to estimate the b coefficients and to study the combined effects of the three variables. The significance of coefficients is assessed by student's test at 95% confidence level (P-value must be less than 5%). Only factors and the interactions with significant effects are retained in the model.

The adequacy of the model is evaluated by both the coefficient of determination R² and the adjusted coefficient R²_{adj} (quality is better as coefficients are closer to 1) and the model P-value. The response surfaces were then drawn using the Design-Expert[®]10 software.

2. Results and discussion

2.1. The Specific flux reduction

The analysis of the polynomial model coefficients (see Table 5) indicated that SFR mainly depend on the BWI as its positive linear effect is high and significant. Moreover, the b₁₋₂ coefficient corresponding to the interaction (X₁-X₂) between the factors BWI and BWD is insignificant (P-value > 5%) and therefore can be eliminated from the model. Considering only the statistically significant coefficients, the empirical model with coded values for the SFR is:

$$SFR = 17.06 + 5.39X_1 - 1.5X_2 - 2.64X_3 + 0.95X_1^2 + 1.12X_2^2 + 1.85X_3^2 - 0.76X_1X_3 - 0.93X_2X_3 \quad (4)$$

The empirical model is statistically significant in the studied range with P-value < 0.01. The determination coefficient R² = 0.93 and the adjusted coefficient R²_{adj} = 0.89 show the validity of this model to explain the variation of the specific flux reduction.

Table 4

The Uncoded design table: factors and responses.

Experiment	BWI (min)	BWD (s)	BWF (L.min ⁻¹)	NWP (L)	SFR %
1	30	15.00	10	2691	16.97
2	90	15.00	10	2530	30.48
3	30	45.00	10	2694	16.97
4	90	45.00	10	2634	27.74
5	30	15.00	34	2646	17.23
6	90	15.00	34	2666	24.24
7	30	45.00	34	2505	10.15
8	90	45.00	34	2634	21.32
9	30	30.00	22	2643	13.99
10	90	30.00	22	2649	25.34
11	60	15.00	22	2670	21.32
12	60	45.00	22	2646	17.71
13	60	30.00	10	2655	24.24
14	60	30.00	34	2661	16.13
15	60	30.00	22	2709	16.52
16	60	30.00	22	2710	16.13
17	60	30.00	22	2711	16.26
18	60	30.00	22	2713	15.87
19	60	30.00	22	2712	16.52
20	60	30.00	22	2710	15.87
21	47.75	26.46	20	2720	14.13
22	72.25	26.46	20	2680	18.97
23	60	37.07	20	2682	18.52
24	60	30.00	28	2690	17.45

Table 5

The polynomial model coefficients for the SFR response.

Coefficient	Value	P-value %
b ₀	17.06	<0.01***
b ₁	5.39	<0.01***
b ₂	-1.5	<0.01***
b ₃	-2.64	<0.01***
b ₁₋₁	0.95	0.286**
b ₂₋₂	1.12	0.137**
b ₃₋₃	1.85	0.0125***
b ₁₋₂	0.173	15.6
b ₁₋₃	-0.76	0.0719***
b ₂₋₃	-0.93	0.0279***

*5% significance level

The model was used to study the sensitivity of SFR response surfaces on the studied variables and to deduce the optimal experimental conditions. The effects of BWI, BWD and BWF on the SFR are given in Figure 4. Not surprisingly, increasing BWI from 30 min to 90 min (see Figure 4-a-c) results in the increase of fouling (as the SFR increases) at fixed BWF and BWD. For filtration cycles of 90 min (see Figure 4-c), increasing the BWF and BWD to their maximal values (34 L.min⁻¹ and 45 s, respectively) did not allow to reduce clogging to its minimum since the SFR remains higher than 20%. As concluded by Ye et al. [4], when the filtration duration is extended, more irreversible cake layer could be formed and thus, higher SFR is achieved.

Figure 4-a indicates that the lowest SFR is obtained at a BWI = 30 min, BWF > 20 L.min⁻¹ and BWD > 30 s. In this optimal area, the BWD and BWF have no effect on the SFR as the response surface is quasi plane. Thus, it can be recommended that to maintain the BWF and BWD at the lower limit of this area since the increase of those two parameters would lead to a decrease in net water production without improving the unclogging. The effects of the BWI, BWF and BWD on the NWP will therefore be studied.

3.2. Net water production

The values of coefficients and their significances are shown in Table 6. The analysis of the polynomial model indicated that all factors and their interactions have statistically significant effects on the NWP. It should be noted that the linear effects of BWI, BWD and BWF are less dominant than their quadratic and interaction effects. The empirical model with coded values for the NWP is as follow:

$$NWP = 2699.08 - 7.52X_1 - 9.79X_2 - 9.16X_3 - 33.35X_1^2 - 23.22X_2^2 - 22.19X_3^2 + 26.52X_1X_2 + 46.44X_1X_3 - 34.83X_2X_3 \quad (5)$$

In the studied range, the model is statistically significant with P -value < 0.01. R^2 (=0.93) and R^2_{adj} (= 0.89) indicated that the model is valid to explain the NWP variation.

The effect of BWI, BWD and BWF on the NWP are given in Figure 5. The maximal NWP is obtained for BWI = 30 min and 60 min. For BWI = 90 min, the maxima decreases and is obtained in a very narrow area of BWD and BWF (see Figure 5-c).

**Fig. 4.** 3D surface response of SFR at constant BWI. (a) 30 min, (b) 60 min, and (c) 90 min.

Table 6
The polynomial coefficients for the NWP response

Coefficient	Value	P- value%
b ₀	2699.08	<0.01***
b ₁	-7.52	<0.01***
b ₂	-9.79	<0.01***
b ₃	-9.16	<0.01***
b ₁₋₁	-33.35	<0.01***
b ₂₋₂	-23.22	<0.01***
b ₃₋₃	-22.19	<0.01***
b ₁₋₂	26.52	<0.01***
b ₁₋₃	46.44	<0.01***
b ₂₋₃	-34.83	<0.01***

*5% significance level

To assure a maximal net water production at a BWI of 30 min, weak BWF (< 14 L.min⁻¹) is recommended in order to economize the water consumption during backwash (see Figure 5-a). Increasing BWF from 14 to 21 L.min⁻¹ requires decreasing the BWD under 30s. Over 21 L.min⁻¹, the NWP declines even at low BWD.

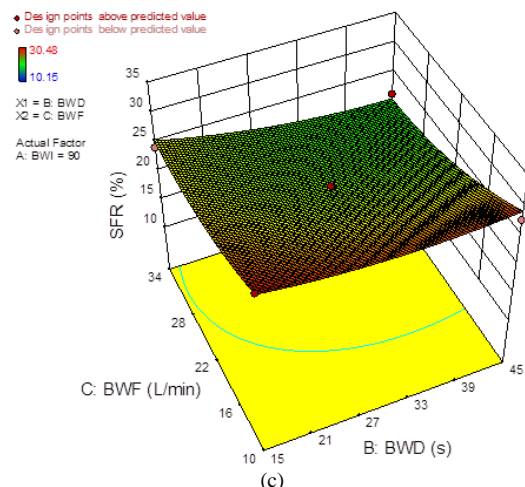
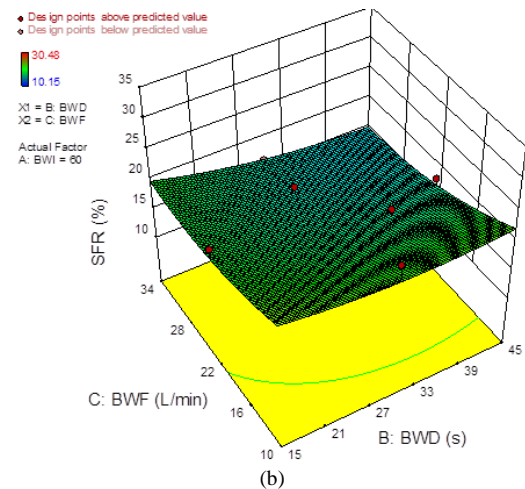
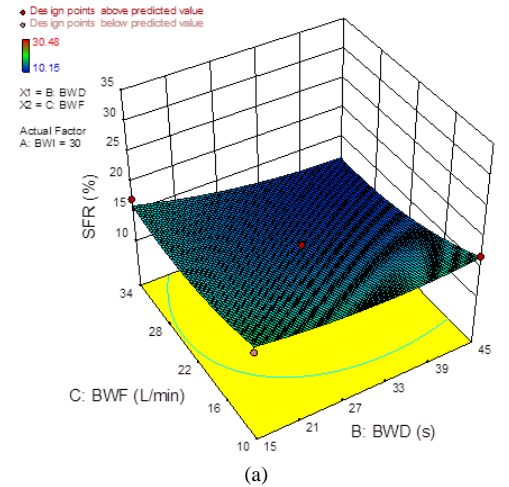
For a BWI = 60 min (see Figure 5-b), the surface corresponding to the optimal NWP is more extended. In others words, the maximum of product water is reached in BWF and BWD ranges larger than those observed at filtration cycles of 30 min. In this case, high BWF > 21 L.min⁻¹ can be sustained by low backwash duration < 29 s, whereas high BWD is required to sustain a weak BWF. The NWP decrease is observed when the BWF and the BWD are higher than 27 L.min⁻¹ and 36 s, respectively, or lower than 14 L.min⁻¹ and 18s. For the first case, the NWP decreases because of a high water consumption during backwash. For the second case, the NWP decline is caused by the excessive fouling accumulation; operating under low BWF and BWD conditions doesn't allow to efficiently remove the deposited particles on the membrane during filtration phases.

3.3. Optimal conditions

There is contradictory relation between physical unclogging and net water production since more backwash for better unclogging is accompanied by less NWP. Thus, for a 60 min operation cycle, the NWP is maximal in a wide BWF and BWD operating range despite greater clogging. Even if the observed clogging at 60 min BWI doesn't affect the NWP (observed here), it would reduce the membrane performances during longer operating times. Thus, it's important for industrial applications to find a good compromise among the operating parameters that assure the right balance between water consumption and deposited particles removal. It can therefore be concluded that BWI 30 min, BWF [10-20 L.min⁻¹] and BWD [15-30 s] are the optimum backwash strategy since it ensures maximal net water production and SFR is reduced to acceptable values.

4. Conclusions

This work deals with the use of Ultrafiltration as seawater pretreatment prior to RO. In the aim to control and eventually regulate clogging during seawater UF it appeared necessary to optimize the backwash parameters (backwash interval, backwash duration, and backwash flow-rate). A surface response study was conducted on the Specific Flux Reduction SFR and Net Water Production NWP in order to find the optimal conditions ensuring the maximum of net water production with the minimum of fouling.

It was found that BWI has the most significant effect on the specific flux reduction and net water production. The effects of BWD and BWF are more important on Net Water Production. The minimal SFR is reached when operating at 30 min filtration cycle and its variation observed in this case is not important as the effects of the backwash flow and duration is not significant. Operating at 30 min of filtration duration allows also reaching the maximal NWP. Generally speaking, the optimal conditions of BWI 30min, BWF interval [10-20 L.min⁻¹] and low BWD [15-30s] were obtained from compromise between both specific flux reduction and net water production responses.

It would be interesting, as a perspective, to study the backwash parameters effect on the energy consumption and thus develop an optimal backwashing strategy that would maximize the net water production while minimizing the cost of production.

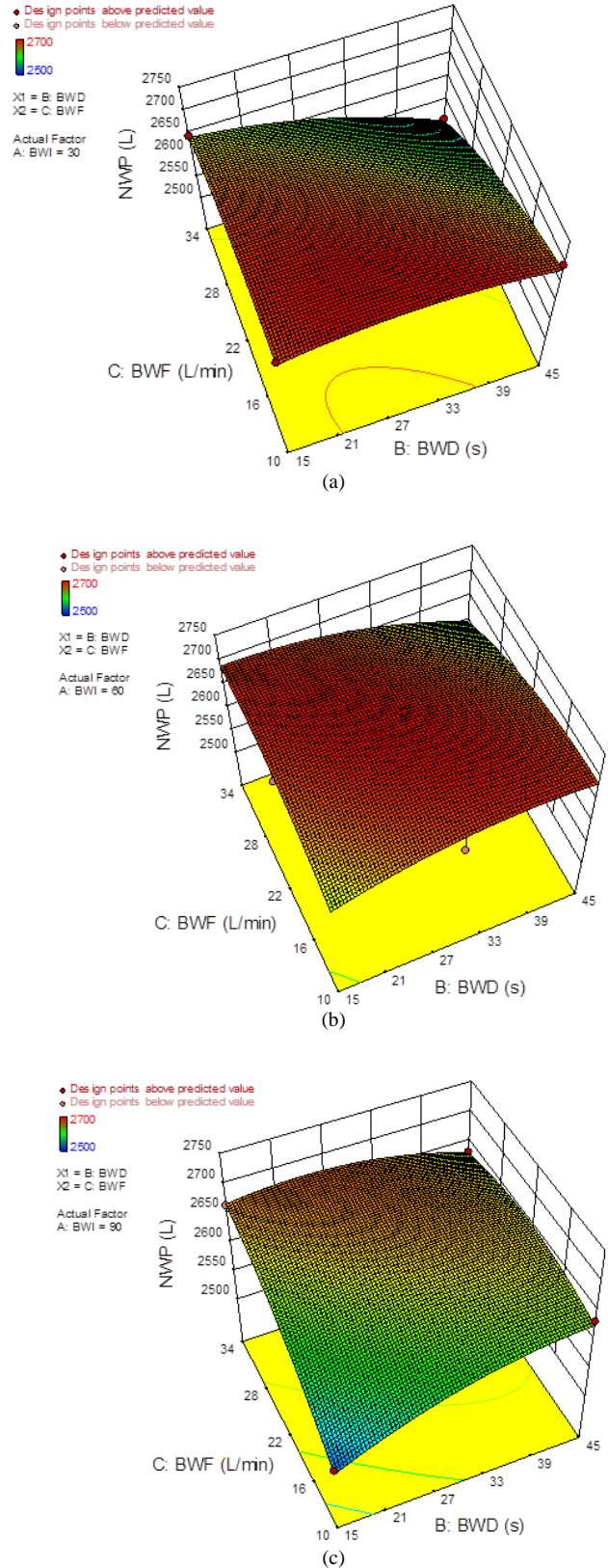

Fig.5. 3D surface response of NWP at constant BWI: (a) 30 min, (b) 60 min, and (c) 90 min.

5. Acknowledgements

The authors would like to thank Mr. Mondher Haddaji, the plant operators and M^{re}. Amira Cherni for their help, the STEG and LAMSIN for the financial support.

6. Nomenclatures

J, J_0	Permeate flux, Initial permeate flux ($L \cdot m^{-2} \cdot h^{-1}$)
Q_0, Q_p	Feed flow, Permeate flow ($L \cdot min^{-1}$)
R^2	Coefficient of determination
R^2_{adj}	Adjusted coefficient of determination
SF	Specific flux ($L \cdot m^{-2} \cdot h^{-1} \cdot bar^{-1}$)
SFR	Specific flux reduction (%)
t	Filtration time (s)
TMP	Trans-membrane pressure (bar)
Y	Conversion rate (%)
BWD	Backwash duration (s)
BWF	Backwash flow ($L \cdot min^{-1}$)
BWI	Backwash interval (min)
NWP	Net water production (L)
RSM	Response surface methodology
UF	Ultrafiltration

References

- [1] A.G. Pervov, A.P. Andrianov, R.V. Efremov, A.V. Desyatov, A.E. Baranov, A new solution for the Caspian Sea desalination: low-pressure membranes, *Desalination* 157 (2003) 377–384.
- [2] L. Wang, X. Wang, K. Fukushi, Effects of operational conditions on ultrafiltration membrane fouling, *Desalination* 229 (2008) 181–191.
- [3] J. Xu, G. Ruan, X. Chu, Y. Yao, B. Su, C. Gao, A pilot study of UF pretreatment without any chemicals for SWRO desalination in China, *Desalination* 207 (2007) 216–226.
- [4] Y. Ye, L.N. Sim, B. Herulah, V. Chen, A.G. Fane, Effects of operating conditions on submerged hollow fibre membrane systems used as pre-treatment for seawater reverse osmosis, *J. Membr. Sci.* 365 (2010) 78–88.
- [5] N.O. Yigit, G. Civelekoglu, I. Harman, H. Koseoglu, M. Kitis, Effects of various backwash scenarios on membrane fouling in a membrane bioreactor, *Desalination* 237 (2009) 346–356.
- [6] M. Raffin, E. Germain, S.J. Judd, Influence of backwashing, flux and temperature on microfiltration for wastewater reuse, *Sep. Purif. Technol.* 96 (2012) 147–153.
- [7] K.J. Hwang, C.S. Chan, K.L. Tung, Effect of backwash on the performance of submerged membrane filtration, *J. Membr. Sci.* 330 (2009) 349–356.
- [8] E. Barbot, P. Moulin, Swimming pool water treatment by ultrafiltration–adsorption process, *J. Membr. Sci.* 314 (2008) 50–57.
- [9] P.J. Smith, S. Vigneswaran, H.H. Ngo, R. Ben-Aim, H. Nguyen, A new approach to backwash initiation in membrane systems, *J. Membr. Sci.* 278 (2006) 381–389.
- [10] C. Cojocaru, G. Zakrzewska-Trznadel, A. Jaworska, Removal of cobalt ions from aqueous solutions by polymer assisted ultrafiltration using experimental design approach. part 1: Optimization of complexation conditions, *J. Hazard. Mater.* 169 (2009) 599–609.
- [11] J. Landaburu-Aguirre, E. Pongrácz, P. Perämäki, R. L. Keiski, Micellar-enhanced ultrafiltration for the removal of cadmium and zinc: Use of response surface methodology to improve understanding of process performance and optimization, *J. Hazard. Mater.* 180 (2010) 524–534.
- [12] S.M.S. Shahabadi, A. Reyhani, Optimization of operating conditions in ultrafiltration process for produced water treatment via the full factorial design methodology, *J. Sep. Purif. Technol.* 132 (2014) 50–61.
- [13] J. Dasgupta, A. Singh, S. Kumar, J. Sikder, S. Chakraborty, S. Curcio, H.A. Arafat, Poly (sodium-4-styrenesulfonate) assisted ultrafiltration for methylene blue dye removal from simulated wastewater: Optimization using response surface methodology, *J. Environ. Chem. Eng.* 4 (2016) 2008–2022.
- [14] A.W. Zularisam, A.F. Ismail, M.R. Salim, M. Sakinah, T. Matsuura, Application of coagulation–ultrafiltration hybrid process for drinking water treatment: Optimization of operating conditions using experimental design, *J. Sep. Purif. Technol.* 65 (2009) 193–210.
- [15] J.P. Wang, Y.Z. Chen, Y. Wang, S.J. Yuan, H.Q. Yu, Optimization of the coagulation-flocculation process for pulp mill wastewater treatment using a combination of uniform design and response surface methodology, *J. Water Res.* 45 (2011) 5633–5640.
- [16] X.S. Yi, W.X. Shi, S.L. Yu, X.H. Li, N. Sun, C. He, Factorial design applied to flux decline of anionic polyacrylamide removal from water by modified polyvinylidene fluoride ultrafiltration membranes, *Desalination* 274 (2011) 7–12.
- [17] K. Guerra, J. Pellegrino, J.E. Drewes, Impact of operating conditions on permeate flux and process economics for cross flow ceramic membrane ultrafiltration of surface water, *J. Sep. Purif. Technol.* 87 (2012) 47–53.
- [18] J. Paul Chen, S.L. Kim, Y.P. Ting, Optimization of membrane physical and chemical cleaning by a statistically designed approach, *J. Membr. Sci.* 219 (2003) 27–45.
- [19] M. Pourabdollah, A. Torkian, M. Hosseinzadeh, A New Approach to Modeling Operational Conditions for Mitigating Fouling in Membrane Bioreactor, *J. Water Environ. Res.* 88 (2016) 2198–2208.
- [20] G.G. Oriol, N. Moosa, R. Garcia-Valls, M. Busch, V. Garcia-Molina, Optimizing seawater operating protocols for pressurized ultrafiltration based on advanced cleaning research, *J. Desal. Water Treat.* 51 (2013) 384–396.