



## Research Paper

# Monopolar and Platinum Interfaced Bipolar Membrane Electrodialysis: Experimental Assessment Using Synthetic Salt Solution Heterogeneous Cation Exchange Membranes

Krishnaveni Venugopal, Sangeetha Dharmalingam\*

Department of Mechanical Engineering, Anna University, Guindy Chennai 600025, Tamil Nadu, India

## ARTICLE INFO

Received 2015-06-25  
 Revised 2015-07-20  
 Accepted 2015-07-21  
 Available online 2015-07-21

## KEYWORDS

Current efficiency  
 Desalination  
 Water splitting  
 Platinum intermediate  
 Reproducibility

## HIGHLIGHTS

- Reinforced monopolar and bipolar IEM preparation using functionalized PSEBS polymer
- Effect of platinum metal in BPM interface on water splitting was analyzed
- Synthetic NaCl solution of brackish water range was used
- Reproducibility of the membranes in BPMED performance was checked

## ABSTRACT

In this study, polystyrene ethylene butylene polystyrene (PSEBS) was functionalized to prepare mono and bipolar ion exchange membranes. In the case of the bipolar membrane, platinum was used as the intermediate layer. NaCl solution of concentration ranging from 5 g/L to 25 g/L was used as the feed solution. A commercially procured ion exchange membrane made of polystyrene divinyl benzene was also evaluated for the purpose of comparison. The BPMED performance reached the highest current efficiency of 69.54% and 53.6% with the energy consumption of 0.37 Wh and 1.39 Wh for the synthesized and commercial membranes, respectively. Also the performance of the fabricated unit was assessed in terms of electrical conductivity, salinity and ion (sodium and chloride) concentrations for the feed solution after 8-hour duration. The reproducibility performance of the membranes was also analyzed for the synthetic salt solution.

## GRAPHICAL ABSTRACT

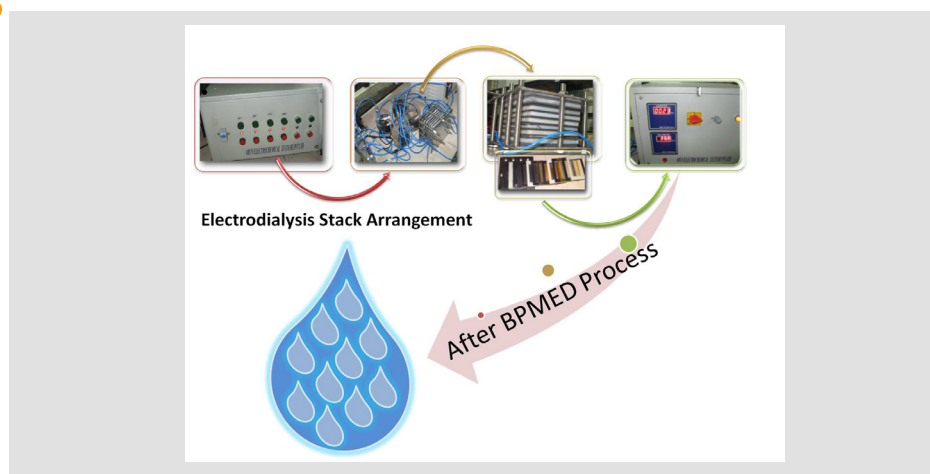

© 2016 MPRL. All rights reserved.

## 1. Introduction

One of the basic requirements in the modern industry of many developing and industrialized countries includes the reliable production of quality water for the process and power industries. One such technique used for the production of quality water is desalination using the electro dialysis (ED) process. In spite of its diversity in classification, ED can be summarized as a

type of technology which arranges ion-exchange membranes (IEM) (cation-selective, anion-selective and/or bipolar membranes) alternately in a direct current field [1]. The quality of feed water is one of the determining factors to decide the type of membrane process. The feasibility of the ED process strongly depends on the selectivity of the membranes. Each technique has its own merits and limitations in application. The advantages of IEM technology

\* Corresponding author at: Phone: +91 044 22357763, fax: +91 044 22357744  
 E-mail address: sangeetha@annauniv.edu (S. Dharmalingam)

in water treatment processes include recovery and separating components from dilute wastes, capability of handling hazardous wastes and the possibility of recycling components present in the waste and/or regenerating chemicals. However, IEM processes have some limitations that include low concentration in the effluent to be treated, lack of selectivity against specific target ions and susceptibility to fouling by organic substances present in wastewater.

In general, membranes of either monopolar or bipolar nature can be defined as a thin layer of electrolytic barrier which can separate two phases and restrict the transport of various chemical species through it depending upon the nature of the membrane and the chemical substances present. Undesired salt ion transport across the membranes occurs, leading to product impurities. The Bipolar membrane (BPM) is a special type of catalytic IEM developed for electro-membrane processes splitting water into protons and hydroxyl ions that can be used for the production of acids and bases from the corresponding salt solutions [2]. BPM can be prepared by simply laminating conventional cation- and anion- exchange membranes. Laminated BPMs often exhibit an unsatisfactory chemical stability at high pH and poor water splitting capability with high electrical resistance. However, the presence of heterogeneous materials like ion-exchange resin (IER) particles in a non-conducting polymer matrix in one or both layers of a BPM usually resulting in BPM with higher mechanical stability [3, 4]. Hence, in the present study, all the monopolar and bipolar IEMs were prepared with resin and glass fiber reinforcements.

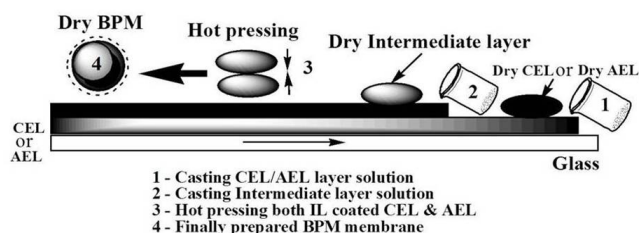

Fig. 1. Diagrammatic representation of methodology used in BPM preparation.

However, BPMs do not perform efficient water dissociation if they are prepared with anion and cation exchange layers only. To improve the performance of a BPM, a thin interface layer (IL), containing a water dissociation catalyst, is generally introduced between the charged layers. The water dissociation rate is accelerated for a fixed electric potential across the contact region, when a catalyst is present. The catalyst reduces the activation energy of the water dissociation because it provides alternative reaction paths by forming reactive, activated complexes. As catalysts in the bipolar junction, immobile weak acids or bases such as quaternary [5], non- quaternary amine group [6], weak acid such as phenolic, carboxylic acid or phosphoric acid groups [7] and its corresponding base, inorganic substances such as Mg, Ni, Co, Mn, Cu, Fe and Al [8], metallic oxides, hydroxides and heavy metal ion compounds such as ruthenium tri-chloride, chromic nitrate, indium sulfate, hydrated zirconium oxide, etc. [9, 10], heavy/noble metal ions like  $\text{Cr}^{3+}$ ,  $\text{Fe}^{2+}$ , Ag, Au, Pt, Pd, Os, Rh, Ti, Sn, Zn, Zr, Pa, Ru etc. [11, 12], macromolecules (such as polyethylene glycol (PEG), polyvinyl alcohol (PVA) [13,14]) and bi-macromolecule (bovine serum albumin (BSA) containing both carboxylic and amino groups [15], starburst dendrimer polyamidoamine (PAMAM) [16] etc., could be used between the charged layers where the desired water dissociation occurs [17]. The water dissociation rate in a BPM was found to be 50 million times faster than the ordinary water dissociation in aqueous solution [18] in the presence of catalyst. It should be noted that bipolar membrane electro dialysis (BPMED) processes can be performed with different stack configurations, depending on the desired application [19-22]. Hence in the present work, the membrane stack configuration of the BPMED unit comprised of five compartments: two electrolyte compartments (EC), one feed compartment (FC), one acid compartment (AC) and one base compartment (BC) for the recovery of acid and base from the corresponding salt solution.

The present study highlights the work designed to evaluate the desalination efficiency of prepared monopolar (CEM and AEM) and bipolar (with Platinum as IL) IEM with resin and glass fiber reinforcements using polystyrene ethylene butylene polystyrene (PSEBS). Platinum has the greatest economic importance in various applicatory fields such as automobiles, oil refining, glassmaking, medical instruments, electronics, dentistry, jewelry, computers, fertilizers, plastics, fuel cells, etc. which have also urged the use of water treatment applications. In addition, its certain properties such as superior conductivity, resistance to oxidation and strong catalytic property

compared to other types of intermediates have shown platinum as one of the best choices to be used as intermediate for BPM in the present study. The study was conducted for five different synthetic salt water concentrations ranging from 5 g/L to 25 g/L of NaCl solution (used in FC) in terms of conductivity, solution pH, transport number of ions (T. No.), feed concentration, current efficiency (CE), energy consumption, water dissociation efficiency (WDE), water dissociation flux and acid-alkali production in the AC and BC up to 8 h. The stack performance using the synthesized membranes was compared with that of the commercial polystyrene divinylbenzene based (PSDVB) IEM under similar experimental conditions. In addition, the decrease in sodium-chloride ion concentration, salinity and electrical conductivity of the feed water were observed and the reproducibility test for the membrane system was conducted with highest CE.

## 2. Materials and methods

The commercially strong acid cation exchange membrane (CMI - 7000S) and commercially strong base anion exchange membrane (AMI - 7001S) were procured from Membranes International INC, New Jersey, USA. While, BPM made up of PSDVB were procured from Arun Electro chemicals, Chennai, glass fiber was purchased from Meena glass fiber industry. Seralite (Cation Exchange resin (CER) - equivalent to Amberlite IRC - 120, 20-50 mesh standard grade) and Seralite (Anionic exchange resin (AER) - equivalent to Amberlite IRA - 400, 20-50 mesh standard grade) were obtained from Sisco Research Laboratory Pvt. Ltd. (SRL). Platinum chloride (Pt) was purchased from Aldrich (USA).

### 2.1. Reinforced IEM preparation

Anionic and cationic functionalized ionomer membranes of sulfonated polystyrene ethylene butylene polystyrene (SPSEBS) and quaternized polystyrene ethylene butylene polystyrene (QPSEBS) was carried out as per the procedure reported earlier [23, 24]. Surface modification is considered to be one of the ways to minimize undesired properties or to introduce additional functions like higher ion exchange capacity (IEC) with firmness and durability for a polymer separation membrane. The reinforced cationic exchange membrane (RCEM) and reinforced anionic exchange membrane (RAEM) based on the PSEBS polymer was prepared by first dispersing a specific quantity (from 10 % to 70 %) of dried (60 °C for 24 h in an oven) and crushed CER/AER in either SPSEBS-Tetrahydro furan (THF) solution or QPSEBS-THF solution, respectively for 12 h using a magnetic stirrer at room temperature. In order to break the aggregates and to obtain a uniform dispersion, the solution was sonicated for 30 min. Then, the solution was cast on a clean glass petridish and the glass fiber matrix was placed to get immersed in the solution before drying in the oven for 24 hours at 45 °C.

The obtained membranes with various resin content were subjected to conductivity studies and from Table 1, it was observed that the conductivity of the prepared membranes increased with an increase in IER loading up to 50 %, beyond which the membranes became brittle from its soft nature. Hence, the resin loading was optimized at 40% for both resins [25]. The reinforced bipolar membrane (RBPM i.e. RPSEBS-Pt) was prepared using RCEM (RSPSEBS) and RAEM (RQPSEBS) as CEL and AEL, respectively [26]. Then on one side of both CEL and AEL layers, a solution containing approximately 6 mL of 0.12 g of Pt contained solution was coated to form the IL. Finally, the IL coated side of both layers (CEL and AEL) were sandwiched and subjected to hot press to finally obtain RBPM represented as RBPM-Pt as shown in Figure 1.

Table 1  
Optimization of resin loadings in PSEBS polymer using its conductivity.

% of resin added	CER Conductivity (S/cm)	AER Conductivity (S/cm)
10	5.2x10 <sup>-5</sup>	1.17x10 <sup>-7</sup>
20	7.1x10 <sup>-4</sup>	3.2x10 <sup>-5</sup>
30	2x10 <sup>-4</sup>	3.7x10 <sup>-5</sup>
40	7.1x10 <sup>-4</sup>	5.0x10 <sup>-5</sup>
50	6.6x10 <sup>-5</sup>	2.5x10 <sup>-5</sup>
60	7.1x10 <sup>-5</sup>	1.0x10 <sup>-6</sup>
70	4.8x10 <sup>-5</sup>	1.8x10 <sup>-6</sup>

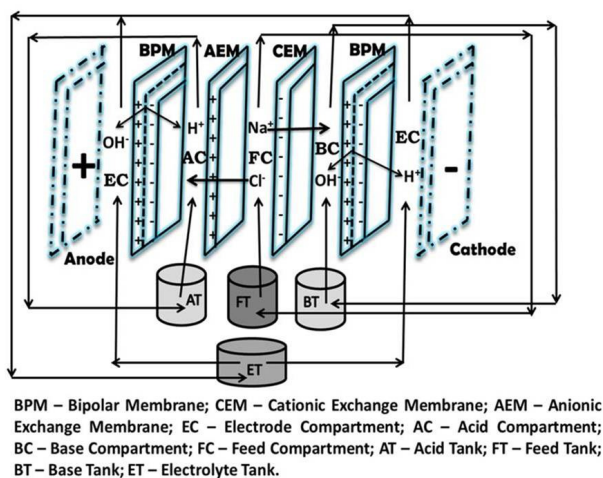

Fig. 2. Schematic representation of BP MED stack setup

## 2.2. Construction and working of the BP MED unit

The BP MED unit used in the study for determination of desalination process efficiency was supplied by Arun Electrochemical, Chennai. The construction and description of the used BP MED unit is shown in Figure 2 [27]. The cathode and anode electrodes used were stainless steel and Ti coated with Ti-Ru-Pd oxides, respectively. The active membrane area of each membrane and volume of each chamber was about 120 cm<sup>2</sup> and 160 cm<sup>3</sup> respectively. Each compartment was connected to a tank of 1 L capacity, allowing for batch mode recirculation of external solutions by submersible pumps at the flow rate of 30 dm<sup>3</sup> h<sup>-1</sup>. In order to minimize the cell voltage generated during the initial stages of the performance, dilute HCl (0.01 N) and dilute NaOH (0.01 N) solutions were used in AC and BC, respectively. And 0.05 mol/L of NaCl solution was used in each EC. Since at lower concentrations, higher resistances between membranes resulted and at higher concentrations, the selectivity nature of the IEMs became lower, NaCl solution of concentrations ranging from 5 g/L to 25 g/L was taken in the FC in order to avoid the higher rate of salt ion leakage across BPM and the

formation of undesired salt impurities in products during BP MED performance. During the performance, at every 15 min time interval, various process parameters were evaluated using the same set of equations as reported earlier [28]. After 8h of treatment, the final solutions of various synthetic feed concentrations and reproducibility test samples were analyzed for their sodium-chloride ion concentration, salinity and electrical conductivity.

## 3. Results and discussion

### 3.1. pH change in various compartments with time

Figures 3 and 4 represent the variation of solution pH in FC, EC, AC and BC with time for brackish water feed concentration range including its reproducibility for both laboratory synthesized RPSEBS-Pt IEM and commercially procured PSDVB IEM systems. It was clear from these figures that with an increase in salt or feed concentration, the initial pH value of the corresponding solution was also found to be higher in FC for both IEM systems. In the case of the RPSEBS-Pt IEM system (Figure 3), pH in FC showed acidic nature at their final stages. This is because with increasing time higher quantities of acid were produced due to water dissociated products, thereby resulting in proton leakage through IEMs depending on the capacity of protons to undergo back diffusion [27]. On the other hand, as per Figure 4 in case of the PSDVB IEM system, the feed solution finally became basic in nature for all feed concentrations. The PSDVB based cell experienced greater leakage of ions from BC to FC and thus it remained basic in nature. Moreover, proton leakage through IEM was low due to low acid concentration that was produced during the BP MED process using PSDVB IEM systems [29].

Whereas in the case of EC, since 0.05 M NaCl was taken as electrolyte solution each time, the initial pH remained constant for all performances. Though both systems showed the final solution to be acidic in nature, the acidity was greater for the PSDVB IEM system than the RPSEBS-Pt IEM system. The difference in pH observed between the two types of IEM systems in FC and EC was mainly attributed to the leakage of ions occurring through membranes arranged between the compartments in a stack. Similarly in the case of AC and BC, the solution pH was found to be approximately around 2.45 and 10.74, respectively for all performances because of the dilute acid and base solutions that were initially taken.

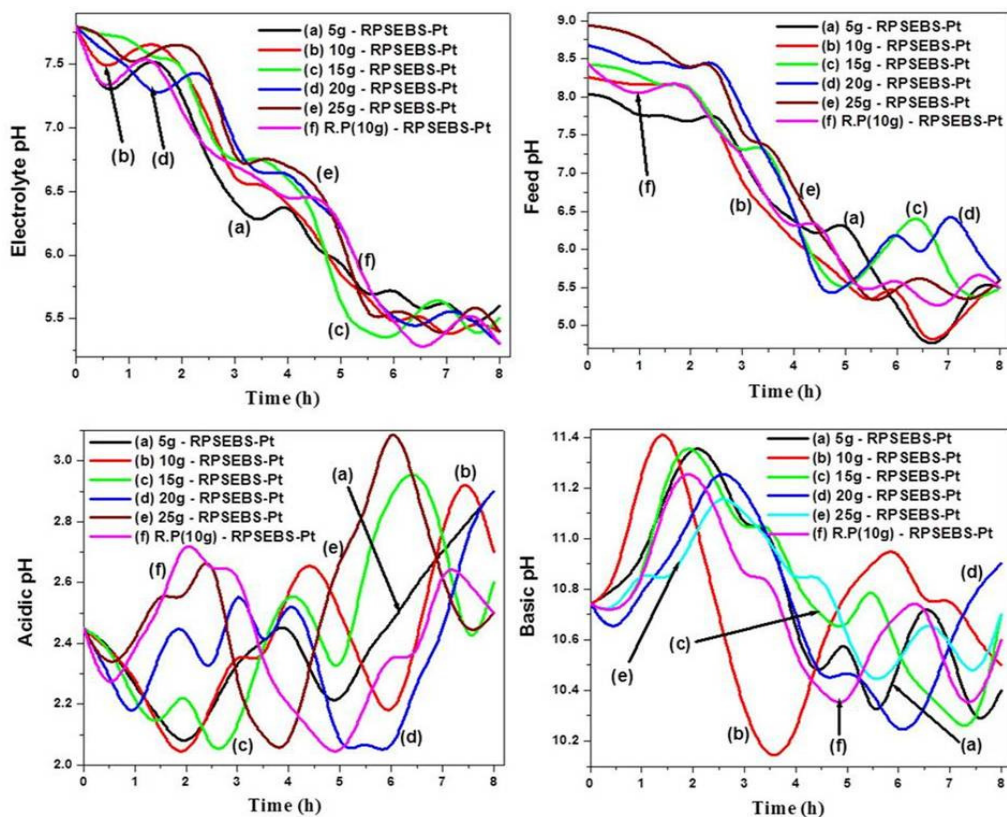

Fig. 3. pH changes in FC, EC, AC and BC with time for various feed concentrations of RPSEBS-Pt IEM system.

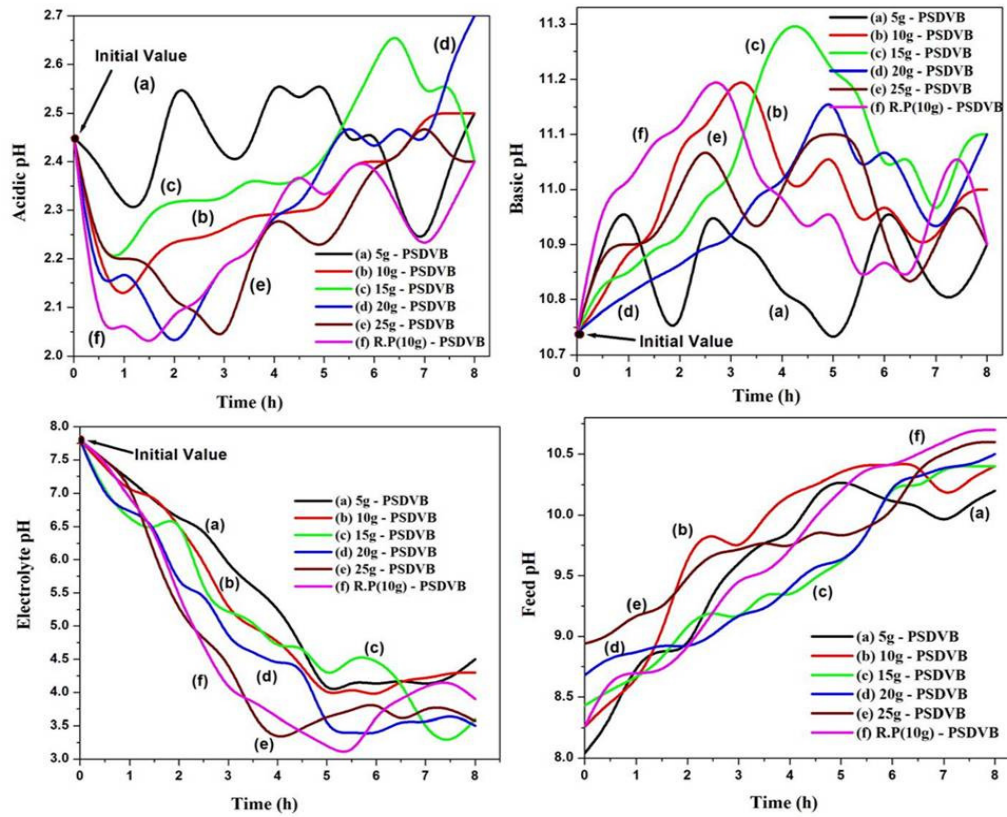

Fig. 4. pH changes in FC, EC, AC and BC with time for various feed concentrations of PSDVB IEM system.

From Figures 3 and 4, it was additionally observed that irrespective of whether it was AC or BC, the acidity or basicity was found to get increased during the first half stage of a performance and the increase was not uniform because of the leakage of some ions into the neighboring compartments. The nature of pH change reflected their acid and base production for both PSDVB

and RPSEBS-Pt IEM systems. This pH change in various compartments clearly suggested that both IEM systems possessed adequate capacity to split water into its co-ions under the influence of the electric field. Also, it should be observed that for the reproducibility test, more or less the same result as that of its original feed concentration was noticed.

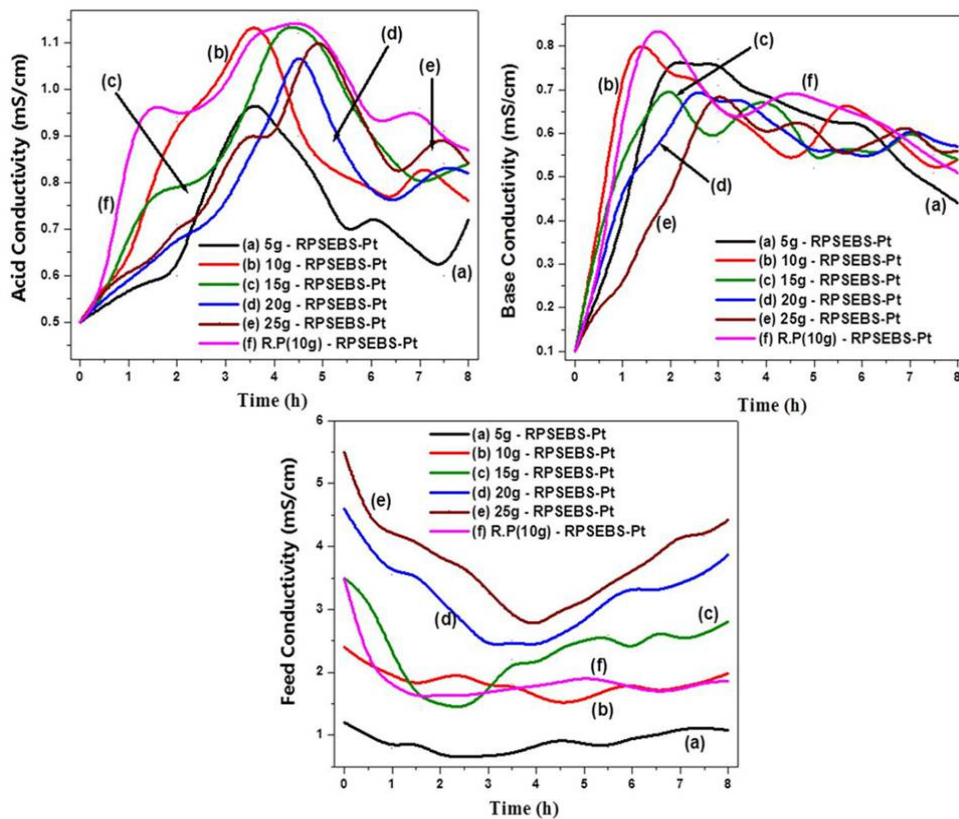

Fig. 5. Conductivity changes in AC, BC and FC for different feed concentrations with time for RPSEBS-Pt IEM system.

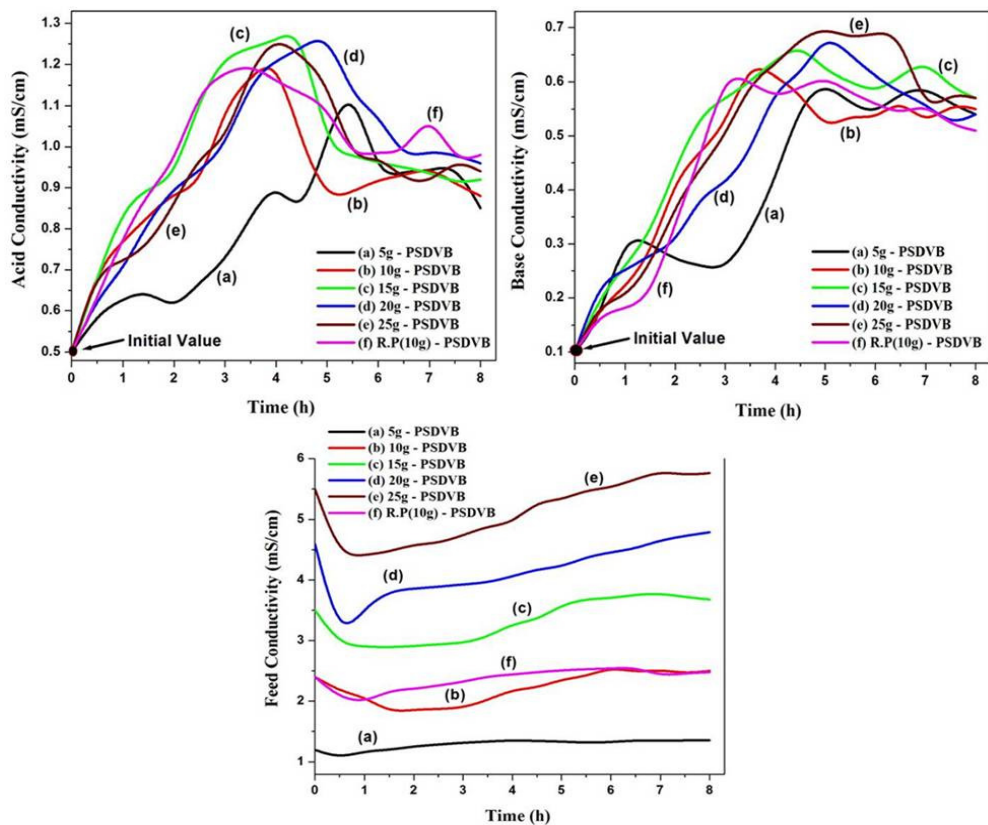

Fig. 6. Conductivity changes in AC, BC and FC for different feed concentrations with time for PSDVB IEM system.

### 3.2. Variation of acid, base and feed conductivities with time

The changes in pH values are justified using its respective conductivity values. Since the ionic mobility of protons was higher than that of the hydroxyl ions, correspondingly, the conductivity value was found to be higher in the case of AC when compared with BC. For the RPSEBS-Pt IEM system, from Figure 5 the highest acid and base conductivity observed was 1.16 mS/cm and 0.82 mS/cm, respectively. After reaching the highest conductivity, either a decrease or an increase was expected mainly due to the loss of ions from acid-base compartments or introduction of other ions from the neighboring compartments. In case of FC, a wide range in decrease of conductivity was observed which was then followed by an increase that did not exceed the initial conductivity of that particular feed concentration.

For the PSDVB IEM system from Figure 6, the highest acid and base conductivity values were found to be 1.29 mS/cm and 0.7 mS/cm, respectively. In addition, the lower acid and base conductivity values for 5 g/L among other feed concentrations indirectly proved its lower acid and base pH change. In the case of FC, the conductivity initially decreased depending upon the feed concentration, which then increased slightly and finally remained constant with time. This increased conductivity was observed to be a little higher than its initial value of that particular feed concentration mainly due to the leakage of ions that occurred from the neighboring compartments through the IEM into FC. It should also be noticed that the reproducibility test in both these cases showed more or less the same results as that of its original feed concentration.

### 3.3. Effect of the BPMED process on acid-base production

When the entire BPMED cell was kept under an electric field using electrodes, due to the large electric field appearing at the membrane interface, an excess of  $\text{OH}^-$  and  $\text{H}^+$  ions was produced due to the field enhanced chemical reaction as per the Second Wien effect. Along with this,  $\text{Na}^+$  and  $\text{Cl}^-$  ions were also continuously transported through IEMs from FC into BC and AC, respectively resulting in the formation of acid and base of certain concentrations which was evidently proven by pH and conductivity studies. The maximum concentration of both NaOH and HCl depended on feed concentration, time, IEC and the functional group nature of that membrane.

However, Figure 7 (a) clearly shows that the RPSEBS-Pt IEM system produced higher acid and base concentrations of about 0.014 N and 0.006 N for the same feed concentration. It has to be noted that once the higher concentration of acid/base was reached in a particular feed concentration, it

remained constant until a certain duration of time after which it decreased with an increase in process time due to the decrease of NaCl concentration or diminished mass transfer of  $\text{Na}^+$  and  $\text{Cl}^-$  ions in the feed solution.

It was observed from Figure 7 (b) that the PSDVB IEM system showed higher acid and base concentrations of about 0.009 N and 0.006 N, respectively for various feed concentrations. Though the PSDVB based IEM cell is meant for base production rather than acid production because of the higher specific permselectivity of CEM for  $\text{H}^+$  ions as per reported in the literature [30], in the present study it was observed from Figure 7 (b) that the alkalinity concentration was lower in case of the PSDVB IEM system. Furthermore,  $\text{H}^+$  ions in the presence of water have a higher intrinsic mobility than  $\text{OH}^-$  ions, thereby resulting in more leakage of  $\text{H}^+$  ions through AEM which led to a decrease in the concentration of acid in AC [31]. A similar decreasing trend was also observed in the case of BC for various feed concentrations. Again, it should be noticed that the reproducibility test in both types of IEM systems showed more or less the same results as that of its original feed concentration.

### 3.4. Ion transport number and WDE changes with time

Since CE depends upon the ion transport and ionic mobility, for a better process efficiency it was expected that the system should have both higher T. No. of ion and better WDE. Figures 8 and 9 represent T. No. properties of both sodium and chloride ions and WDE for RPSEBS-Pt and PSDVB IEM systems. From these figures it was clear that depending upon the membrane capacity, time and feed concentration, T. No. of both  $\text{Na}^+$  ion and  $\text{Cl}^-$  ions was observed to have a higher value at its initial stage and then started decreasing with time for both types of IEM systems. In case of WDE, both systems initially showed the lowest value which then increased with time and then remained constant. This is because at the beginning of the BPMED process, since NaCl concentration was higher in FC, a transfer of a large amount of  $\text{Na}^+$  and  $\text{Cl}^-$  ions through IEM was observed. But with increasing time due to a decrease of NaCl concentration, the current was carried by water dissociated products such as  $\text{H}^+$  and  $\text{OH}^-$  ions.

From Figure 8, the RPSEBS-Pt IEM system showed the highest T. No. of 0.44 and 0.36 for chloride and sodium ions, respectively. Similarly from Figure 9, PSDVB IEM system showed a greater T. No. of 0.16 and 0.08 of chloride and sodium ions respectively, for the same feed concentration. While in the case of WDE, as per Figure 8 the RPSEBS-Pt IEM system showed results of about 0.86 and 0.87 for both the highest and lowest feed concentrations, respectively.

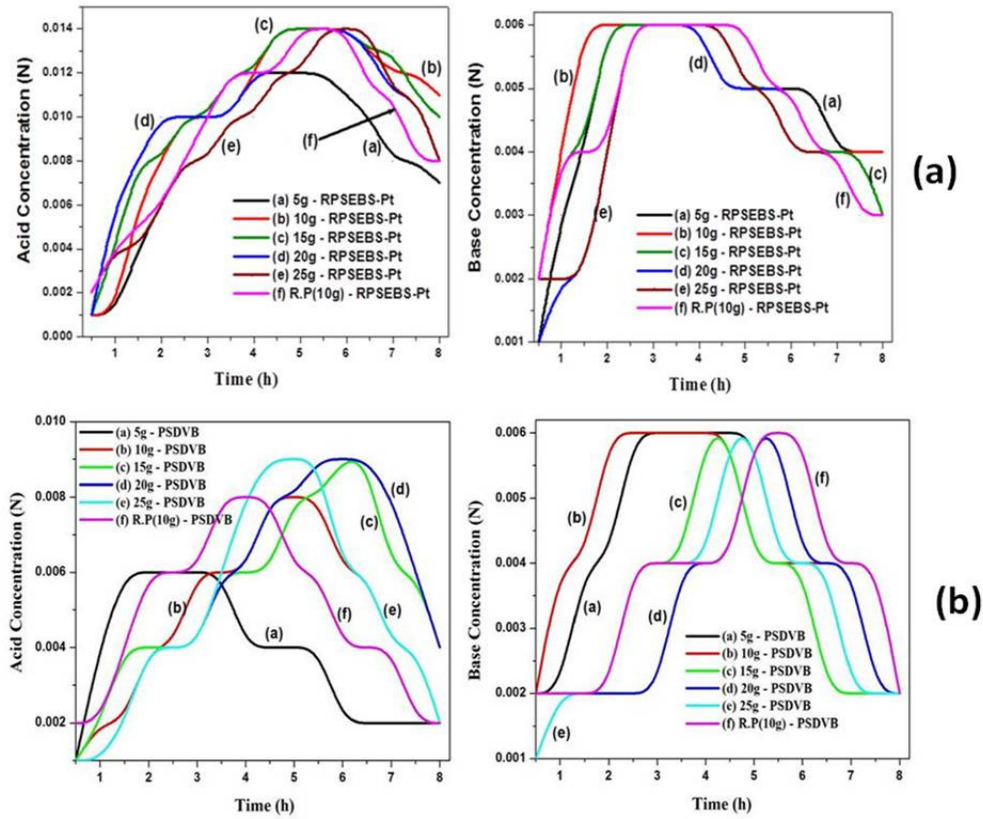

Fig. 7. Changes in acid-base yield with time for various feed concentrations for (a) RPSEBS-Pt IEM system and (b) PSDVB IEM system.

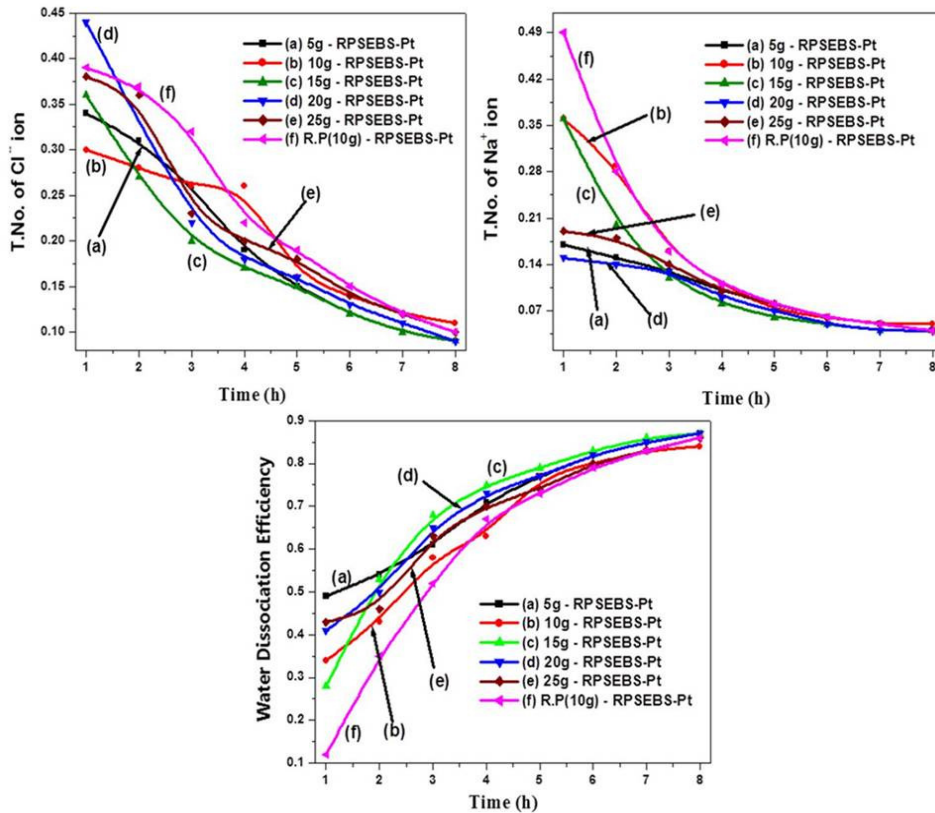

Fig. 8. Changes in T. No. of ions and WDE for various feed concentrations with time for RPSEBS-Pt IEM system.

The reason for this difference was mainly due to the salt concentration in FC and hence, when the feed concentration was lower it was a better opportunity for the transport of water dissociated ions. But when the feed concentration was higher, the competition between these ions would be higher and more preferably the salt ion transport initially occurred followed by the water

dissociated ions [30]. Whereas per Figure 9, the highest WDE value observed for the PSDVB IEM system was about 0.07. The highest T. No. and steady increase in WDE with time observed for the RPSEBS-Pt IEM system was mainly due to the increase in the electric field, pre-polarization of water molecules at the membrane-solution interface and the presence of a catalytic

Pt intermediate between the two monopolar layers of BPM [32]. In the reproducibility test for RPSEBS-Pt IEM systems, a lower value was obtained for the T. No. of both ions, whereas WDE showed higher performance when

compared with that of its original feed concentration performance. For the PSDVB IEM system, T. No. of both chloride and sodium ions was observed to be less and the WDE showed a more or less similar performance.

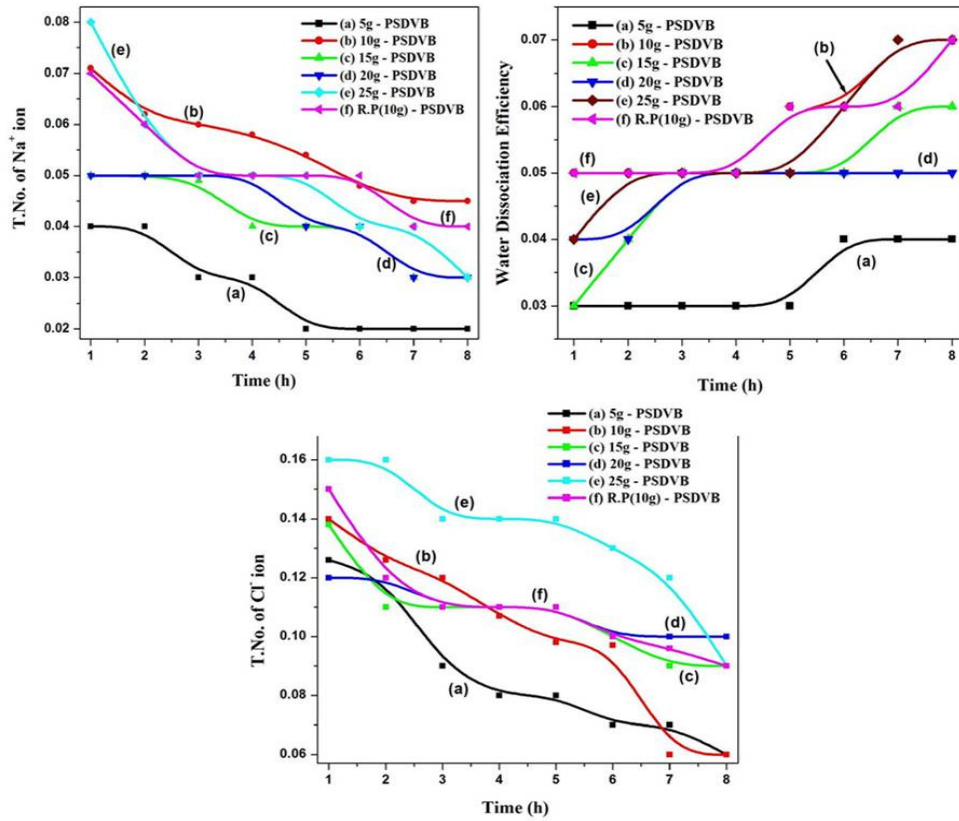

Fig. 9. Changes in T. No. of ions and WDE for various feed concentrations with time for PSDVB IEM system.

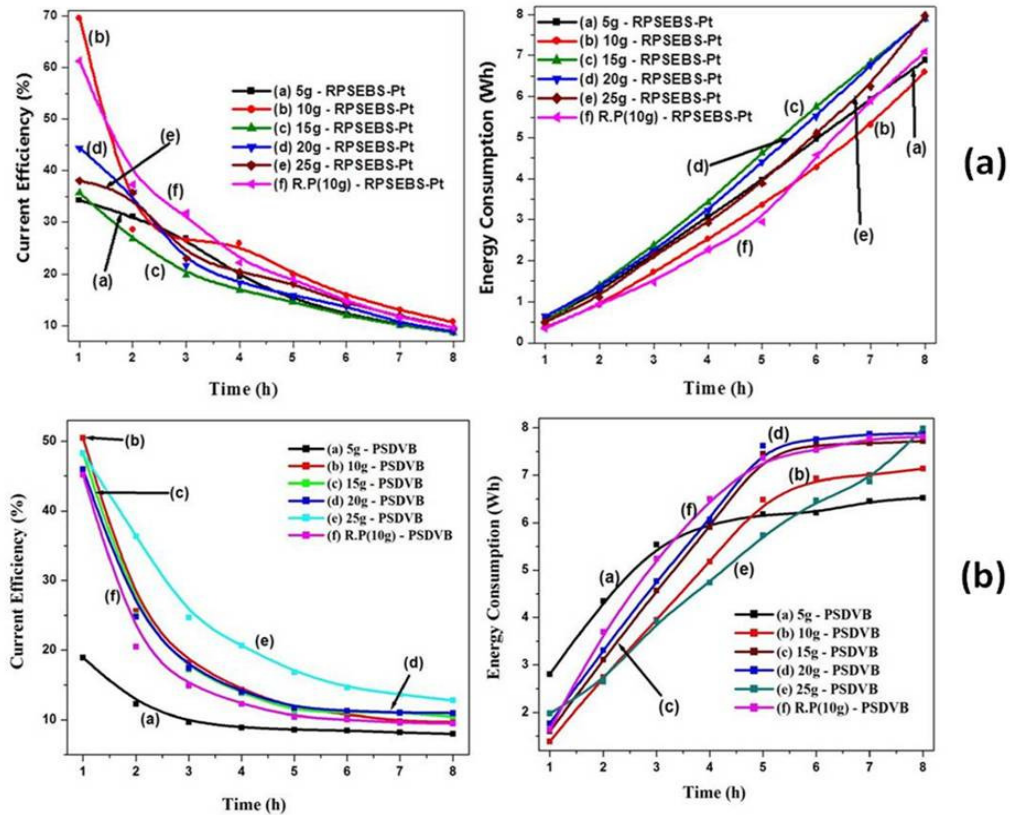

Fig. 10. Variation of CE and energy consumption for various feed concentrations with time for (a) RPSEBS-Pt IEM system and (b) PSDVB IEM system.

### 3.5. Determination of process efficiency parameters with time

For any system, higher CE with lower energy consumption is one of the factors which determines the feasibility of any electrochemical process towards higher process efficiency. Figure 10 represents the variation of CE and energy consumption of both the RPSEBS-Pt and PSDVB IEM system with time for various feed concentrations. It was observed that both CE and energy consumption increased with an increase in feed concentration due to the same reason as discussed for T. No. of ions and WDE. With an increase in time, CE was observed to decrease for each feed concentration mainly due to leaching out of resin particles from the functionalized polymer because of ballooning, flexible and higher elongation nature of the polymer when placed in water for a longer duration of time. The reason for the increase in energy consumption with time was mainly due to the electrical resistance in various compartments. The increase of resistance in FC resulting from the exhaustion of NaCl in the solution can be offset by the decrease of electrical resistance in AC and BC caused by the increase of acid-base concentrations as a consequence of transfer of  $\text{Cl}^-$  and  $\text{Na}^+$  ions from the feed solution.

In the case of the RPSEBS-Pt IEM system as per Figure 10 (a), the

highest CE and energy consumption values observed were about 69.5 % and 0.37 Wh respectively for 15 g/L feed concentration. In the case of the PSDVB IEM system, the same was observed to be 53 % and 1.39 Wh, respectively for 10 g/L feed concentration from Figure 10 (b). From Figure 10 (a), the RPSEBS-Pt IEM system showed a uniform increase in energy consumption with time until the final stages of the experiment without any observation of oscillations with respect to various feed concentrations. This was mainly because of the presence of IER in addition to the fiber reinforcements during the membrane preparation which created an increased electrical resistance. In order to overcome this additional resistance, the RPSEBS-Pt IEM system consumed a little additional energy until the final stage of a performance resulting in the steady increase in value. Whereas from Figure 10 (b), although the PSDVB IEM system displayed oscillations at the initial stages, its increase in energy consumption with time finally depended upon its feed concentration. In terms of the reproducibility test, CE was observed to be lower and energy consumption was observed to be higher than its original feed concentration for both types of the IEM system because the membrane loses some of its IEC and functional groups depending on its usage time.

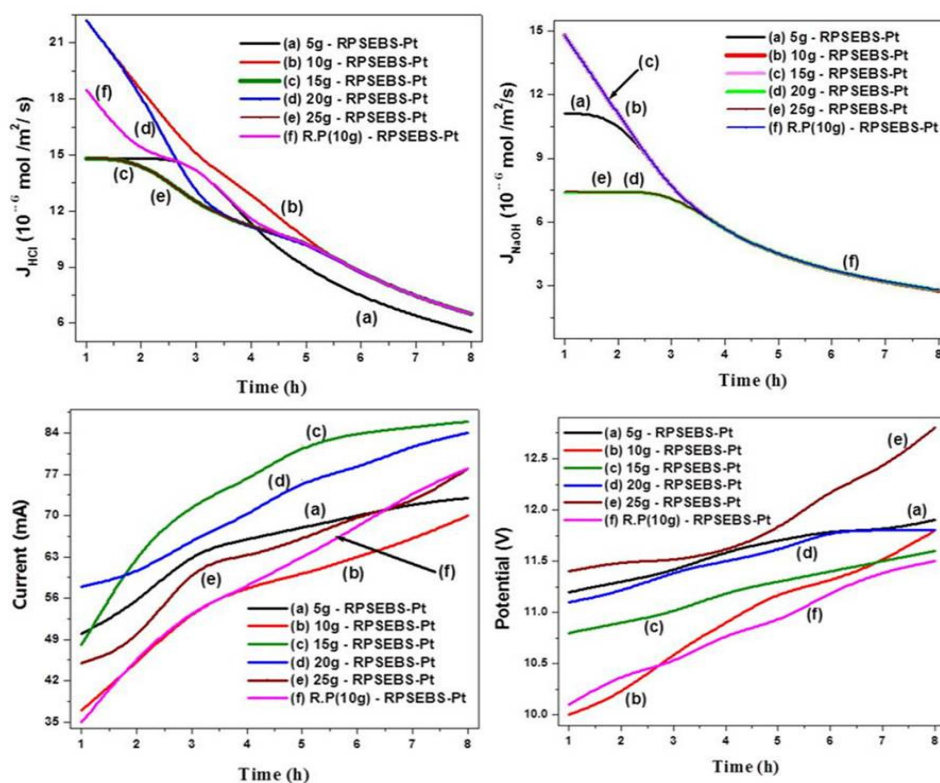

Fig. 11. Variation of current, potential, protons and hydroxyl ions water dissociation fluxes with time for RPSEBS-Pt IEM system.

### 3.6. Variation of current, potential and water dissociation fluxes with time

Figures 11 and 12 reveal the relationship between current, potential and water dissociation flux of protons and hydroxyl ions with time for various feed concentrations of both RPSEBS-Pt and PSDVB IEM systems. Similar to the results of Michael Rajesh et al. [32], it was clear from Figures 11 and 12 that the current increased with time for both systems depending upon the feed concentration. The reason was mainly because of the production of  $\text{OH}^-/\text{H}^+$  during water dissociation and overall decrease of stack resistance due to resistance difference in various compartments caused by IEM. The maximum current finally observed for the lowest and highest feed concentrations was about 73 mA and 78 mA, respectively for RPSEBS-Pt and it was about 105 mA and 89 mA, respectively for the PSDVB IEM system.

The voltage variation slightly increased with time and attained a maximum value, depending upon feed concentration which then decreased. This is because the production of acid and alkali increased with an increase in voltage to some extent, after which a further increase in voltage deteriorated the membrane properties as discussed by Trivedi et al. [33]. The highest volt reached by the RPSEBS-Pt IEM system among various feed concentrations was about 12.8 V as per Figure 11 and it was about 23.1 V for the PSDVB IEM system from Figure 12. The reason for the observed lower voltage for the RPSEBS-Pt IEM system can be explained theoretically using the

protonation and de-protonation reactions model and the hydrophilicity change in the interface [13].

From Figures 11 and 12, it was clear that for both IEM systems whether acidic or basic, the water dissociation flux was observed to decrease with time for the various feed concentrations mainly due to the depletion of  $\text{Na}^+$  ions in the anode compartment and  $\text{Cl}^-$  ions in the cathode compartment. As per Figure 11, the higher acid and basic fluxes observed were about  $22.2 \times 10^{-6} \text{ mol m}^{-2} \text{ s}^{-1}$  and  $14.8 \times 10^{-6} \text{ mol m}^{-2} \text{ s}^{-1}$  in AC and BC, respectively for the RPSEBS-Pt IEM system. And for the PSDVB IEM system, the same was about  $14.8 \times 10^{-6} \text{ mol m}^{-2} \text{ s}^{-1}$  and  $3.7 \times 10^{-6} \text{ mol m}^{-2} \text{ s}^{-1}$  respectively. The greater flux values for the RPSEBS-Pt IEM system confirmed the catalytic activity of the Pt intermediate layer at the BPM interface by means of hydrogen bonding and polar interaction between Pt and water molecules.

In the reproducibility test in the case of the RPSEBS-Pt IEM system, both acidic and basic fluxes were observed to be closer to its original feed concentration. This is while the current change was higher and the potential change was also slightly higher at their initial time and lower during the latter stage of the performance than the original. In case of the PSDVB IEM system, the reproducibility test revealed that the dissociation fluxes were lower than the original feed concentration; while both potential and current values were observed to be higher.

Tables 2 and 3 represent the electrical conductivity, salinity and sodium-



chloride ion concentrations in 100 mL of various feed sample solutions for both RPSEBS-Pt and PSDVB IEM systems. It should be noted that all these parameters increased with an increase in feed concentration mainly because of two reasons: (i) increased NaCl concentration in the feed solution and (ii) restricted transport of sodium and chloride ions through IEMs because of decreased membrane capacity due to the adhesion of the salt ions on the surface of the membrane, especially during higher feed concentration and at a longer duration of time. Though the transfer of  $\text{Na}^+$  and  $\text{Cl}^-$  ions from FC to

neighboring compartments under the electric field was confirmed by lower electrical conductivity, sodium and chloride ion concentrations of final feed solutions, the effectiveness of the process for both types of IEM systems was confirmed through salinity measurements (Tables 2 and 3). The higher difference between the initial and final values for all these parameters represents the process effectiveness in removal of NaCl and higher acid-base production. The reproducibility test results can also be discussed in a similar way.

**Table 2**

Electrical conductivity, salinity and sodium-chloride ion concentration values for various final feed solutions using RPSEBS-Pt IEM system.

Final feed sample solution	Electrical conductivity (mS/cm)		Salinity (%)		Chloride ion concentration (mg/100 mL)		Sodium ion concentration (ppm)	
	Initial	Final	Initial	Final	Initial	Final	Initial	Final
5 g/L	12.53	6.2	8.2	4.0	35.96	18.6	42.9	12.4
10 g/L	20.90	7.6	14.3	5.0	39.12	24.15	44.4	16.1
15 g/L	30.40	10.0	21.3	6.9	46.69	19.50	46.2	13.0
20 g/L	37.7	17.5	26.9	10.0	54.26	25.05	48.0	16.7
25 g/L	44.9	18.1	33.1	11.6	58.68	30.0	49.1	20.0
Reproducibility test (10 g/L)	20.90	7.8	14.3	6.6	39.12	27.75	44.4	18.5

**Table 3**

Electrical conductivity, salinity and sodium-chloride ion concentration values for various final feed solutions using PSDVB IEM system.

Final feed sample solution	Electrical conductivity (mS/cm)		Salinity (%)		Chloride ion concentration (mg/100 mL)		Sodium ion concentration (ppm)	
	Initial	Final	Initial	Final	Initial	Final	Initial	Final
5 g/L	12.53	11.30	8.2	7.3	35.96	20.8	42.9	24.5
10 g/L	20.90	19.4	14.3	13.9	39.12	27.3	44.4	38.9
15 g/L	30.40	27.5	21.3	19.1	46.69	30.4	46.2	44.3
20 g/L	37.7	31.3	26.9	22.1	54.26	37.6	48.0	45.3
25 g/L	44.9	36.9	33.1	26.6	58.68	43.4	49.1	46.5
Reproducibility test (10 g/L)	20.90	20.4	14.3	14.0	39.12	28.7	44.4	40.0

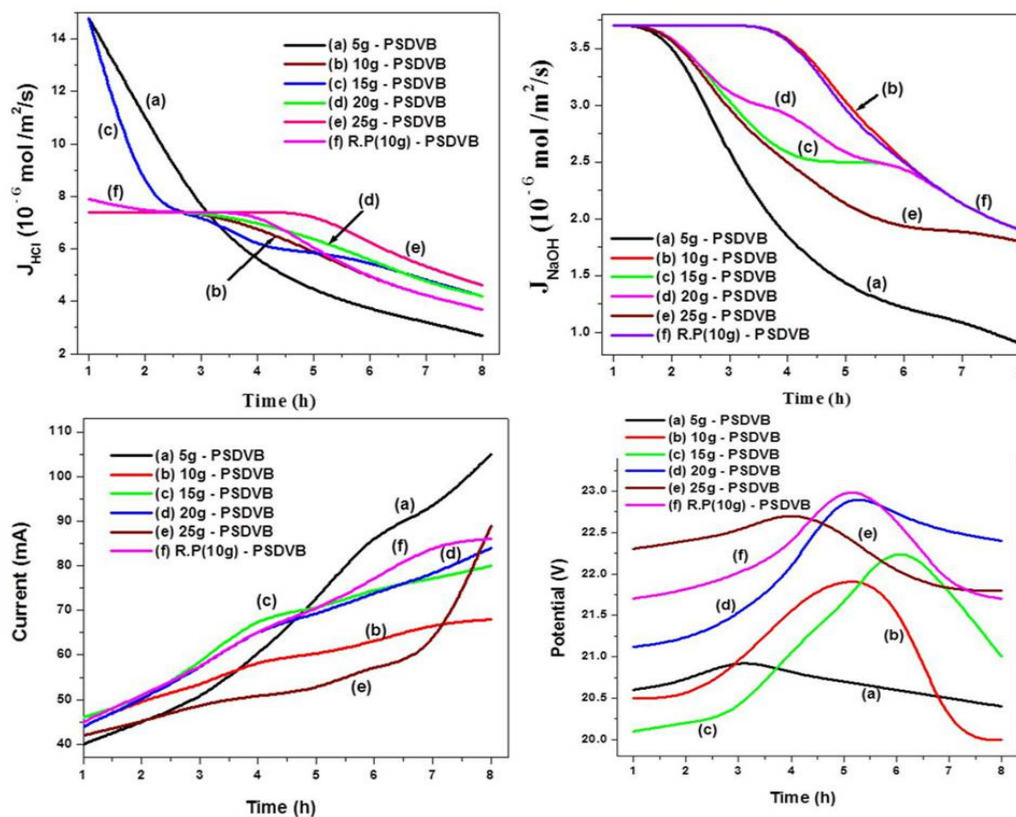
**Fig. 12.** Variation of current, potential, protons and hydroxyl ions water dissociation fluxes with time for PSDVB IEM system.

#### 4. Conclusions

Functionalized PSEBS based resin-glass fiber reinforced monopolar and bipolar (with Pt intermediate) IEMs were prepared and compared with commercial PSDVB IEM in order to evaluate their desalination efficiency for various feed concentrations using BPMED technology. Based on the results obtained for various process parameters such as current efficiency (69.54 % for RPSEBS-Pt and 53.61 % for PSDVB), energy consumption (0.37 Wh for RPSEBS-Pt and 1.39 Wh for PSDVB), acid-base production (0.014 N acid & 0.006 N base for RPSEBS-Pt and 0.009 N acid & 0.006 N base for PSDVB) and WDE (0.86 for RPSEBS-Pt and 0.07 for PSDVB), it can be concluded that the RPSEBS-Pt IEM system showed better performance than that of the commercial PSDVB IEM system. Also, electrical conductivity, salinity and sodium-chloride ion concentration results were observed to be better for the RPSEBS-Pt IEM system than with the PSDVB IEM system due to the presence of a catalytic intermediate region in the RPSEBS-Pt based IEM system.

#### Acknowledgement

This work was supported by the Board of Research in Nuclear Science (BRNS), Mumbai, India under the grant No. 2010/37C/1/BRNS/826, dated: 28-06-2010.

#### Abbreviations

AC	Acid compartment
AEL	Anion exchange layer
AEM	Anion exchange membrane
AER	Anion exchange resin
BC	Base compartment
BPM	Bipolar membrane
BPMED	Bipolar membrane electro dialysis
BVA	Bovine serum albumin
CE	Current efficiency
CEL	Cation exchange layer
CEM	Cation exchange membrane
CER	Cation exchange resin
EC	Electrolyte compartment
ED	Electrodialysis
FC	Feed compartment
IEC	Ion exchange capacity
IEM	Ion exchange membrane
IER	Ion exchange resin
IL	Intermediate layer
NaCl	Sodium chloride
PAMAM	Polyamido amine
PEG	Polyethylene glycol
PSDVB	Polystyrene divinyl benzene
PSEBS	Polystyrene ethylene butylene polystyrene
PVA	Polyvinyl alcohol
QPSEBS	Quaternized polystyrene ethylene butylene polystyrene
RAEM	Reinforced anion exchange membrane
RBPM	Reinforced bipolar membrane
RCEM	Reinforced cation exchange membrane
RQPSEBS	Reinforced quaternized polystyrene ethylene butylene polystyrene
RSPSEBS	Reinforced sulfonated polystyrene ethylene butylene polystyrene
SPSEBS	Sulfonated polystyrene ethylene butylene polystyrene
T. No.	Transport number
THF	Tetrahydro furan
WDE	Water dissociation efficiency

#### References

- V.A. Shaposhnik, V.I. Vasileva, R.B. Ugryumov, M.S. Kozhevnikov, Thermoconvective instability during electro dialysis, Russian J. Electrochem. 42 (2006) 531–537.
- H. Strathmann, H.J. Rapp, B. Bauer, C.M. Bell, Theoretical and practical aspects of preparing bipolar membranes, Desalination 90 (1993) 303–323.
- B. Bauer, F.J. Gerner, H. Strathmann, Development of bipolar membranes, Desalination 68 (1988) 279–292.
- O. Kedem, A. Warshawsky, A supported, mechanically stable bipolar membrane for electro dialysis. Patent to Yeda research and development company, Ltd., Israel, EP 0,504,904 A2; 1992.
- R. Simons, Electric field effects on proton transfer between ionizable groups and water in ion exchange membranes, Electrochimica Acta 29 (1984) 151–158.
- R. Simons, Water splitting in ion exchange membranes, Electrochimica Acta 30 (1985) 275–282.
- N.V. Sheldeshov, N.P. Gnusin, V.I. Zabolotskii, N.D. Pismenskaya, Chronopotentiometric study of electrolyte transport in commercial bipolar membranes, Soviet Electrochem. 22 (1987) 137–142.
- Y. Tanaka, S. Matsuda, Y. Sato, M. Seno, Concentration polarization and dissociation of water in ion exchange membrane electro dialysis, the effects of electrolytes on the dissociation of water, J. Electrochem. Soc. Japan 50 (1982) 667–672.
- M.S. Kang, Y.J. Choi, H.J. Lee, S.H. Moon, Effects of inorganic substances on water splitting in ion-exchange membranes I: Electrochemical characteristics of ion-exchange membranes coated with iron hydroxide/oxide and silica sol, J. Colloid. Interf. Sci. 273 (2004) 523–532.
- M.S. Kang, Y.J. Choi, S.H. Moon, Effects of inorganic substances on water splitting in ion-exchange membranes II: Optimal contents of inorganic substances in preparing bipolar membranes, J. Colloid. Interf. Sci. 273 (2004b) 533–539.
- F. Hanada, K. Hirayama, S. Tanaka, N. Ohmura, Bipolar membrane and method for its production, J.P. Patent 2524012, 1996.
- F.G. Wilhelm, N.F.A. Vejt, M. Wessling, H. Strathmann, Bipolar membrane preparation, in: A.J.B. Kemperman (ed.), Bipolar membrane handbook, Twente University Press, Enschede, The Netherlands, 2000, pp. 79–108.
- R.Q. Fu, T.W. Xu, G. Wang, W.H. Yang, Z.X. Pan, PEG - catalytic water splitting in the interface of a bipolar membrane, J. Colloid. Interf. Sci. 263 (2003) 386–390.
- R.Q. Fu, Y.H. Xue, T.W. Xu, W.H. Yang, Fundamental studies on the intermediate layer of a bipolar membrane Part IV: Effect of polyvinyl alcohol (PVA) on water dissociation at the interface of a bipolar membrane, J. Colloid. Interf. Sci. 285 (2005) 281–287.
- R.Q. Fu, T.W. Xu, W.H. Yang, Z.X. Pan, Fundamental studies on the intermediate layer of a bipolar membrane Part II: Effect of bovine serum albumin (BSA) on water dissociation at the interface of a bipolar membrane, J. Colloid. Interf. Sci. 278 (2004) 318–324.
- R.Q. Fu, T.W. Xu, Y.Y. Cheng, W.H. Yang, Z.X. Pan, Fundamental studies on the intermediate layer of a bipolar membrane Part III: Effect of starburst dendrimer PAMAM on water dissociation at the interface of a bipolar membrane, J. Membr. Sci. 240 (2004) 141–147.
- H. Strathmann, J.J. Krol, H.J. Rapp, G. Eigenberger, Limiting current density and water dissociation in bipolar membranes, J. Membr. Sci. 125 (1997) 123–142.
- M. Wien, Über die Gültigkeit des ohmschen gesetzes für elektrolyte bei sehr hohen feldstärken, Ann. Physik 73 (1924) 161–181.
- V. Chen, H. Lib, A.G. Fane, Non-invasive observation of synthetic membrane processes - a review of methods, J. Membr. Sci. 241 (2004) 23–44.
- V. Cauwenberg, J. Peels, S. Resbeut, G. Pourcelly, Application of electro dialysis within fine chemistry, Sep. Purif. Technol. 22–23 (2001) 115–121.
- L. Bazinet, F. Lamarche, D. Ippersiel, Bipolar-membrane electro dialysis: Applications of electro dialysis in the food industry, Trend. Food Sci. Technol. 9 (1998) 107–113.
- X. Tongwen, Y. Weihua, Effect of cell configurations on the performance of citric acid production by a bipolar membrane electro dialysis, J. Membr. Sci. 203 (2002) 145–153.
- D. Sangeetha, Conductivity and solvent uptake of proton exchange membrane based on polystyrene (ethylene-butylene) polystyrene tri-block polymer, Eur. Polym. J. 41 (2005) 2644–2652.
- R. Vinodh, R. Padmavathi, D. Sangeetha, Separation of heavy metals from water samples using anion exchange polymers by adsorption process, Desalination 267 (2011) 267–276.
- M. Kumar, V.K. Shahi, Heterogeneous-homogeneous composite bipolar membrane for the conversion of salt of homologous carboxylates into their corresponding acids and bases, J. Membr. Sci. 349 (2010) 130–137.
- V. Krishnaveni, D. Sangeetha, Desalination efficiency of a novel bipolar membrane based on functionalized polysulfone, Desalination 296 (2012) 37–45.
- Y. Wang, X. Zhang, C. Huang, T. Xu, Production of monoprotic diprotic, and triprotic organic acids by using electro dialysis with bipolar membranes: effect of cell configurations, J. Membr. Sci. 385 (2011) 226–233.
- V. Krishnaveni, D. Sangeetha, Evaluation of synthetic salt water desalination by using a functionalized polysulfone based bipolar membrane electro dialysis cell, Desalination 344 (2014) 189–197.
- H. Strathmann, G.H. Koop, Process economics of the electro dialytic water dissociation for the production of acid and base, in: A.J.B. Kemperman (Ed.), Handbook on bipolar membrane technology, Twente University Press, Enschede, The Netherlands, 2000, pp. 193–218.
- J. Shen, J. Huang, L. Liu, W. Ye, J. Lin, B.V. Bruggen, The use of BMED for glyphosate recovery from glyphosate neutralization liquor in view of zero discharge, J. Hazard. Mater. 260 (2013) 660–667.
- Z. Liu, M. Zhu, P. Yu, Y. Xu, X. Zhao, Pretreatment of membrane separation of glyphosate mother liquor using a precipitation method, Desalination 313 (2013) 140–144.
- A. Michael Rajesh, M. Kumar, V.K. Shahi, Functionalized biopolymer based bipolar membrane with poly ethylene glycol interfacial layer for improved water splitting, J. Membr. Sci. 372 (2011) 249–257.
- G.S. Trivedi, B.G. Shah, S.K. Adhikary, V.K. Indusekhar, R. Rangarajan, Studies on bipolar membranes, React. Func. Polym. 28 (1996) 243–251.